



WHITE PAPER

Wood fuel in Switzerland: energy potential, technology development, resource mobilization, and its role in the energy transition

Oliver Thees, Matthias Erni, Vanessa Burg, Gillianne Bowman, Serge Biollaz, Theodoros Damartzis, Timothy Griffin, Jeremy Luterbacher, François Maréchal, Thomas Nussbaumer, Tilman Schildhauer, Janine Schweier, Michael Studer, Oliver Kröcher



Impressum

Oliver Thees¹, Matthias Erni¹, Vanessa Burg¹, Gillianne Bowman¹, Serge Biollaz², Theodoros Damartzis³, Timothy Griffin⁴, Jeremy Luterbacher³, François Maréchal³, Thomas Nussbaumer⁵, Tilman Schildhauer², Janine Schweier¹, Michael Studer⁶, Oliver Kröcher^{2,3}

¹ Swiss Federal Institute for Forest, Snow and Landscape Research (WSL), Birmensdorf

² Paul Scherrer Institute (PSI), Villigen

³ Swiss Federal Institute of Technology Lausanne (EPFL), Sion and Lausanne

⁴ University of Applied Sciences and Arts Northwestern Switzerland (FHNW), Windisch

⁵ Lucerne University of Applied Sciences and Arts (HSLU), Luzern

⁶ Bern University of Applied Science (BFH), Zollikofen



HSLU Lucerne University
of Applied Sciences
and Arts



EPFL



n|w University of Applied Sciences and Arts
Northwestern Switzerland

Suggested citation:

Thees, O.; Erni, M.; Burg, V.; Bowman, G.; Biollaz, S.; Damartzis, T.; Griffin, T.; Luterbacher, J.; Marechal, F.; Nussbaumer, T.; Schildhauer, T.; Schweier, J.; Studer, M.; Kröcher, O., 2023: White paper – Wood fuel in Switzerland: energy potential, technology development, resource mobilization, and its role in the energy transition. SCCER-BIOSWEET; Birmensdorf, Swiss Federal Research Institute WSL. 34 pp. <https://doi.org/10.55419/wsl:32791>

This white paper is available in English (original), German and French.

Cover photos: Oliver Thees (WSL), Thomas Fillbrandt (University of Freiburg, Germany)

Editor: Swiss Federal Institute for Forest Snow and Landscape Research WSL, Birmensdorf, 2023



This publication is Open Access and all texts and photos, where not otherwise stated, are subject to the Creative Commons licence CC BY 4.0. They may be freely reproduced, distributed and modified, provided the source is acknowledged.

Aim of the white paper

The aim of this white paper is to provide decision-makers with the **recent research findings** in order to promote the optimal use of bioenergy from wood, as well as from some other solid biomass types, in the Swiss energy transition. For this purpose, results from the Swiss Competence Center for Bioenergy Research – **SCCER BIOSWEET** – are summarized and presented in a broader context regarding the state-of-the-art in research and its implementation in practice. If not specified otherwise, the results refer to Switzerland and, in the case of feedstock, to the domestic biomass potential.

The **focus is on wood** and, especially in the context of combustion technology, solid non-woody biomass, which can potentially be made available for energy production **only if it is not needed for competing material or food resources**. Wood fuel includes wood directly harvested from forests and landscapes, wood residues from industry, and waste wood remaining from wooden products after their utilization. Examples of additionally considered non-woody solid biomass are herbaceous residues from agriculture and food processing.

Partners and acknowledgments

This white paper was financially supported by the Swiss Innovation Agency Innosuisse and is part of the Swiss Competence Center for Energy Research SCCER BIOSWEET.

We thank the following further organizations for support through e.g. collaboration, consultation, data delivery and funding:

- Ammann Schweiz AG, Langenthal; arv Baustoffrecycling Schweiz, Schlieren; Axpo Biomasse AG, Baden; Bundesausschuss für Energie, Bern; COOP, Basel
- European Commission (Projects REsens and Pulp & Fuel), Gaznat SA, Vevey; GEO Partner AG, Zürich
- Heitzmann AG, Schachen; Holzenergie Schweiz, Zürich; Kaskad-E GmbH, Basel; KlimaGRischa Klimastiftung Graubünden, Chur; Liebi LNC AG, Oey-Diemtigen; Oekosolve AG, Plons; SCHMID AG Energy Solutions, Eschlikon

We thank Dr. Sandra Hermle (SFOE), Andreas Keel (Holzenergie Schweiz), Prof. Dr. Karl Keilen (keilenANALYTICS), and Prof. Dr. Frédéric Vogel (FHNW, PSI) for reviewing the manuscript. Finally, we are grateful to Dr. Kurt Bollmann (WSL) for reviewing section 4.3.2 (biodiversity).

For editing, layout and translations we thank: Jacqueline Annen, Sandra Gurzeler, Martin Moritz (all WSL) and Dr. Gillianne Bowman (WSL), Melissa Dawes and TTN Translation Network.

Definitions and abbreviations

- The **bioeconomy** "...encompasses the production of renewable biological resources and the conversion of these resources and waste streams into value added products, such as food, feed, bio-based products and bioenergy" (European Commission 2012).
- **Biogenic carbon** means exclusively renewable carbon (as opposed to fossil carbon such as coal and petroleum), as defined by IEA Bioenergy (2022).
- **Final or end use energy** is the energy delivered to consumers for end consumption, such as electricity for lighting or gasoline for vehicles.
- "The **Global Warming Potential (GWP)** was developed to allow comparisons of the global warming impacts of different gases. Specifically, it is a measure of how much energy the emissions of 1 ton of a gas will absorb over a given period of time, relative to the emissions of 1 ton of carbon dioxide (CO₂). The larger the GWP, the more that a given gas warms the Earth compared to CO₂ over that time period. The time period usually used for GWPs is 100 years" (EPA 2021).
- **Petajoule (PJ)** is the unit used for primary energy, whereas **gigawatt hour (GWh)** is the unit used for end use energy (1 PJ ≈ 278 GWh).
- **Primary energy carriers** (e.g. wood, coal, crude oil, natural gas and water) occur naturally and have not yet undergone any conversions, regardless of whether they are directly usable in their raw form.
- **SNG** stands for synthetic natural gas. It is mainly composed of methane.
- **TRL** means Technology Readiness Level and indicates the extent to which a technology is developed on a scale of 1-9.
- **Wood fuel** or energy wood encompasses wood from forests, wood from trees outside forests (e.g. resulting from landscape maintenance), wood residues from wood processed for material purposes, and finally waste wood, which was previously used as a wooden product.

Summary

To enable the energy transition in Switzerland, SCCER BIOSWEET (i) assessed the current and future potentials of primary energy from the different woody biomass types in Switzerland; (ii) developed and implemented innovative technologies for biomass utilization in the fields of heat, electricity and fuels; and (iii) investigated the future role of woody biomass in the energy system.

SCCER BIOSWEET started with the vision of 100 petajoules (PJ) of primary energy consumption per year from bioenergy by 2050, which means a doubling of the current energy consumption from biomass. According to the results of the analyses completed through SCCER BIOSWEET, this target is achievable and woody biomass could contribute 50%. Nevertheless, with regard to resource efficiency and the decarbonization of industry and society, priority should be given to the material use of wood (cascading use), for example as chemicals produced in biorefineries. In Switzerland, the use of wood for energy would ideally include the production of high-temperature heat for industrial process heating, as well as fuels in gaseous and liquid form for ground- and air-based transportation. A further key point is the need to compensate for fluctuations in the production of other types of energy, especially solar power.

Table of contents

1 Introduction	4
1.1 A competence center for bioenergy research	4
1.2 Current use of wood fuel	4
1.3 Challenges and issues	4
2 Domestic Feedstock	5
2.1 Wood fuel potentials	5
2.2 Forest wood	7
2.3 Future availability of wood fuel	11
3 Technologies for using wood fuel	12
3.1 Overview	12
3.2 Electricity and heat production	13
3.3 Production of gaseous fuels	17
3.4 Production of liquid fuels	20
3.5 Biorefinery: integrated approaches for wood conversion	22
4 The role of woody biomass in the energy system	23
4.1 Material or energy use?	23
4.2 Possibilities for energy use	24
4.3 Optimal energy use	25
5 Conclusions and recommendations	28
6 References	30

1 Introduction

1.1 A competence center for bioenergy research

Switzerland faces a gradual and far-reaching transformation of its energy system. To identify solutions to the technical, social and political challenges linked to the energy transition, the Swiss Federal Council and Parliament launched the “Swiss Coordinated Energy Research” action plan, under which CTI (now Innosuisse), the Swiss National Science Foundation (SNSF), and the Swiss Federal Office of Energy (SFOE) have been mandated to develop and manage interdisciplinary research networks between higher education institutions. Eight Swiss Competence Centers for Energy Research (SCCERs), running from 2014 to 2020 in seven action fields, were established in support of the Swiss Government’s Energy Strategy 2050 (CTI 2013).

SCCER BIOSWEET (BIOmass for SWiss EnErgy fuTure) was a consortium of academic, private and public partners. Its research on biomass was focused on bringing conversion processes to higher technological readiness levels (TRL), with the aim of contributing to solutions for the energy transition. A contribution of 100 petajoules (PJ) primary energy per year from woody and non-woody biomass was envisaged for the year 2050. To reach this target, the current use of biomass for energy would need to be doubled, with wood contributing half of the envisioned value. The research and development activities of SCCER BIOSWEET were geared towards this ambitious goal to sustainably use the potential of biomass as an energy source. BIOSWEET has led to new insights, and the present synthesis is largely based on the information/knowledge gained through the consortium.

1.2 Current use of wood fuel

Wood is a biogenic carbon source that has harvested atmospheric CO₂ via photosynthesis. Living trees in Swiss forests contain about 121 t C/ha (Rigling *et al.* 2015). Today’s solid energy wood is sourced from wood fuels from forests, trees outside forests, wood residues resulting from wood processing for material purposes, and finally waste wood, which becomes available at the end of a wooden product’s life cycle. According to energy statistics (SFOE 2021a), **in 2019 all wood fuels accounted for 4.9% (41 PJ) of the total final energy consumption** in Switzerland (836 PJ). The latter value dropped to 747 PJ in the first pandemic year, 2020, and the share represented by all wood fuels increased to 5.3%.

According to Swiss forestry statistics (FOEN 2022), 1.9 Mm³ (19 PJ) **wood fuel from domestic forests** was harvested in 2019 (and 1.6% more in the first pandemic year 2020). About 60% of this volume was woodchips and 40% logs. The share of woodchips in the total volume of wood fuel from forests has been increasing for years. The **total energy wood consumption** has been increasing for more than 20 years, reaching values of 5.5 Mm³ in 2019 and 5.6 Mm³ in 2020. The largest share (about 70%) was used in automated combustion systems. Woody biomass is mainly combusted to produce heat (95%) and, to a small extent, electricity (5%) in combined heat and power (CHP) plants (500 GWh/a in 2019 and 590 GWh/a in 2020; FOEN 2021, FOEN 2022).

1.3 Challenges and issues

This white paper offers information from current technological and social science research and addresses important opportunities and risks associated with the use of wood and selected solid non-woody biomass types for energy purposes. Because of the many possible uses of biomass, but also the potentially far-reaching ecological effects of these uses, the associated problems are very complex. Depending on the situation, the responsible stakeholders in politics, administration and business can be confronted with the following challenges:

- **Limited raw material and market-dependent potential**, combined with the risk of a lack of availability of biomass resources or uncertainties in supply, often caused by competition, environmental restrictions and forest ownership conditions.
- **High production and logistic costs in the entire process chain**, associated with the risk of reduced economic efficiency and competitiveness and with the difficulty in mobilizing additional potential in the forest (related to costs, to the wood market due to co-products, and to uncertainties resulting from climate change and political requirements). Similar problems occur in agriculture and food industry. Regarding costs, these are unlikely to become lower during the energy transition, in contrast to other renewable options, which benefit from economies of scale.
- **Negative environmental impacts on individual processes**, in particular unsustainable nutrient removal during forest wood harvesting and air pollution mainly in the form of particulate matter and organic compounds from small combustion devices, as well as ash disposal problems.

- **Suboptimal allocation of resources in terms of energy and resource efficiency, as well as carbon footprint, in particular for wood:**
 - Energy use that occurs too early in the process chain (not following the cascade of material use, or circular use, prior to energy use).
 - Applications involving low-temperature heat production only instead of combined power or fuel and heat production, which achieves a higher energy value and has a greater impact in terms of substituting for fossil fuels.
- These activities would lead to a reduction in the maximum contribution to climate protec-

tion, resource conservation and sustainable development.

- **High technical requirements to use low-grade solid biomass.** Compared with wood, solid biomass from non-woody sources such as grain residues and coffee grounds are lower quality fuels, due to their high content of ash, nitrogen and other compounds that interfere with a thermal treatment. Thus, new combustion technologies to exploit the energy potential of wood and other types of solid biomass are needed, in particular technologies that can be applied to low-grade fuels.

2 Domestic Feedstock

2.1 Wood fuel potentials

Wood fuel includes all sources of woody biomass used for energy (forest wood, wood from trees outside the forest, wood residues from sawmills and joineries, and waste wood that has already been used materially). In principle, only wood grown in Switzerland was included in the potential analysis shown below, which is based on a previous comprehensive study (Thees *et al.* 2017; Burg *et al.* 2018). However, residual wood (from joineries) and waste wood contain some non-domestic wood, which has been accounted for as available domestic potential. Pellets are a derivative primarily of sawmill residues and were not included in the wood fuel potentials to avoid double counting.

Note that the wood fuel potentials presented here are part of the study mentioned above covering all relevant biomass types, based on Swiss data from 2014 to 2016. There are no comparable studies from Switzerland based on more recent data. The potentials are market- and climate-dependent and therefore not constant; nevertheless, the figures are still reliable in terms of their magnitude.

The upper limit – **the theoretical potential** – of all domestic biomass resources is 209 PJ/a primary energy (Burg *et al.* 2018) (Fig. 1). The share of wood fuel that is theoretically available is 56%, corresponding to 117 PJ/a. The main constraints on the availability of sustainably produced biomass for energy use are caused by ecological and economic restrictions. Taking these restrictions into consideration the theoretical potential for the yearly bioenergy production is roughly halved, which means that **the sustainable potential** is 97 PJ/a from all types of biomass and 50 PJ/a when considering woody biomass only (50 PJ/a ~ 14 TWh/a, which means 5.43 Mt/a biogenic CO₂). Subtracting the biomass or wood fuel already used leads to **the additional sustainable po-**

tential: around 44 PJ/a of the Swiss biomass (4% of the gross energy consumption), or **14 PJ/a in the case of woody biomass, is additionally available for generating energy** (Fig. 1). However, these potentials are currently not used, mainly due to economic reasons.

Forest wood has the greatest wood fuel potentials of all woody biomass (Fig. 1). Its sustainable potential (26 PJ/a) is greater than the sum of the other three types of woody biomass (24 PJ/a). The spatial distribution shows considerable differences between the flat terrain and the mountainous regions (for details see section 2.2.4). The sustainable potential of **wood residues** (8 PJ/a) is mostly found on the Central Plateau, particularly in the northeastern part of Switzerland, where wood industries are concentrated. While half of the potential occurs in sawmills, the other half is scattered across numerous wood processing facilities. There is no additional potential for these wood residues, which are used for energy or as material for particle board, depending on the market situation. The sustainable potential of **waste wood** is 12 PJ/a, with major differences between regions. It ranges from a few kg to more than 200 kg per inhabitant and year. One-third of the theoretical waste wood potential is exported and used abroad, half for material and half for energy use (Erni *et al.* 2017; Thees *et al.* 2017). The sustainable potential of **trees outside forests** (5 PJ/a) is mainly located in the populated regions of the Central Plateau and the Rhine and Rhone valleys. Potentials also exist in more alpine regions, mainly in the form of hedges and along waterways, but they are barely accessible.

To implement wood fuel potentials for the transformation of the energy system, it is important to understand their distribution on the municipal level (Fig. 2). **When expressed per km² of land, the greatest potentials are found in the Jura and**

Primary energy content (PJ)

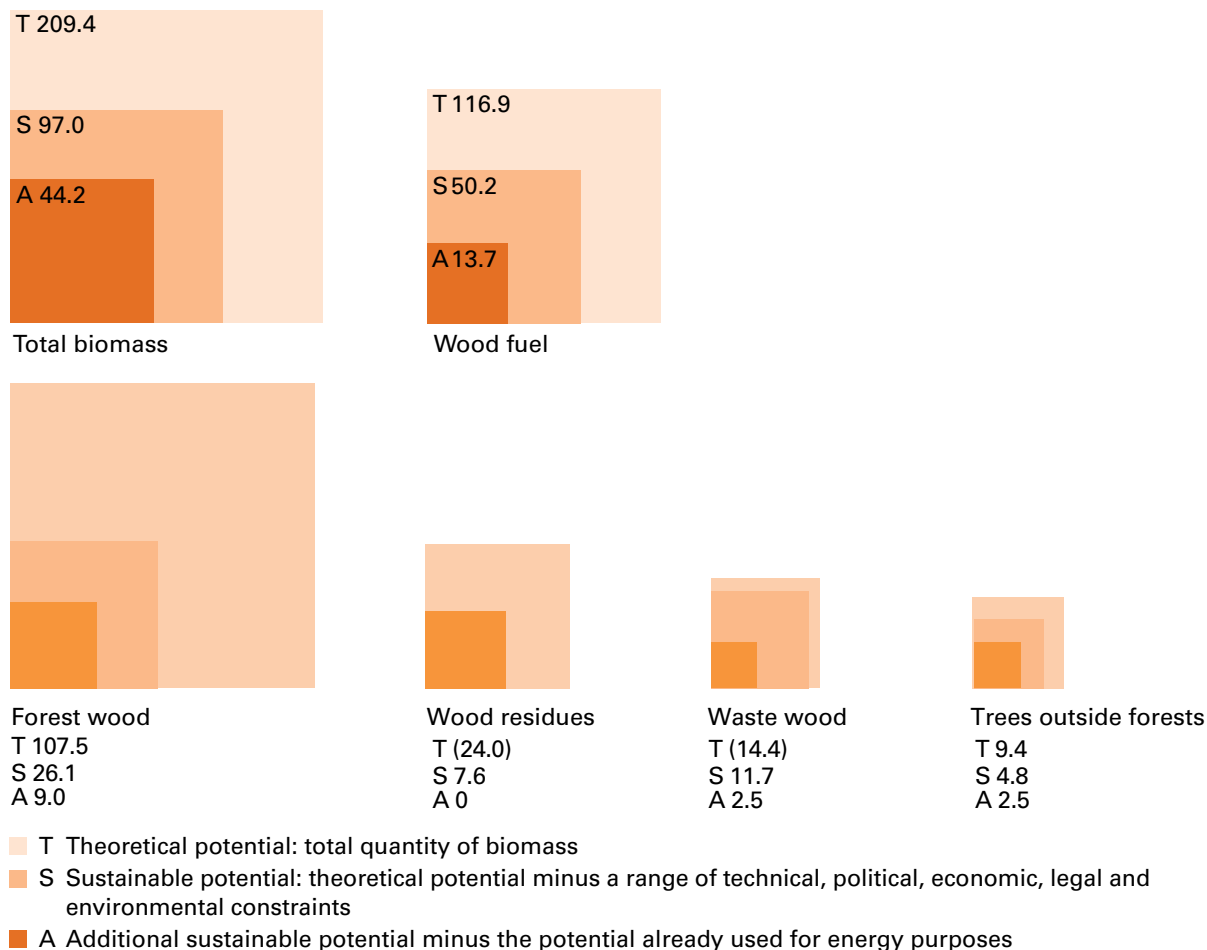

Figure 1: Annual total biomass and wood fuel potentials of the four relevant types of woody biomass in Switzerland. The area of each square is proportional to the primary energy quantity it represents. For wood fuel from forests, the figure refers to forests with medium-intensity management equivalent to a moderate stock reduction and a less energy-wood-friendly market (i.e. material valuation dominates the timber market, Thees *et al.* 2020). Note: forest wood and trees outside forests are the sources of all domestic woody biomass and its subsequent uses. Therefore, adding the theoretical potentials of forest wood and industrial wood residues or waste wood leads to double counting because the potential of processed wood (wood residues, waste wood) is partly based on trees grown domestically. It should also be noted that the potentials may be subject to uncertainties that are difficult to quantify (see section 1.3).

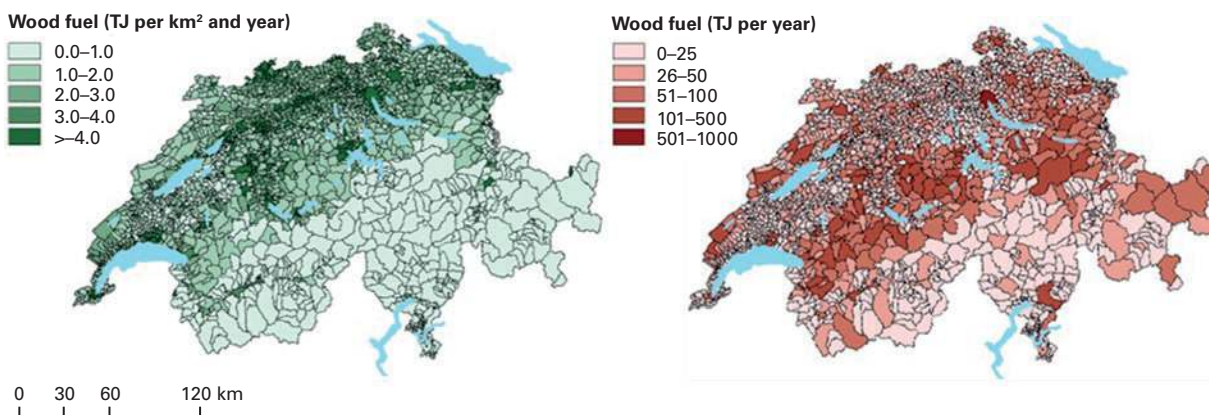

Figure 2: Ecologically and economically sustainable wood fuel potentials per municipality in the year 2014: relative values in terajoules (1 TJ = 0.001 PJ) per km² and year (left) and absolute values in TJ per year (right). More information is available at map.geo.admin.ch (under “woody biomass”).

the Central Plateau (Fig. 2 left). When the potentials of the individual municipalities are considered, the largest potentials are found in the Pre-Alps and the Alps (Fig. 2 right).

To better understand the situation on the Central Plateau in Switzerland, the feasibility of the energy transition in the canton of Aargau was studied comprehensively regarding all forms of renewable energy (Lemm *et al.* 2020). Different strategies to satisfy the local demand for electricity, heat and fuel by 2035 were explored, in particular the potential contribution of biomass. The results indicated that sustainably available renewable energy sources in Aargau will probably not be sufficient to cover its forecasted energy demand in 2035, neither with presently available nor with future biomass conversion technologies. Within these scenarios, 74% of the energy demand could be met by renewable energy sources. **Biomass energy can increase the degree of autarky by up to 13%, with wood fuel contributing about half.** Depending on the scenario, 26–43% (2500–5700 GWh) of the total energy demand is not met, particularly for mobility purposes. These results demonstrate that the energy system transformation cannot be considered only at the local level; the overall system on the national and the international level must be considered to develop sustainable and reliable solutions.

2.2 Forest wood

Forest wood is the main source of wood fuel, yet its potential is not a stable quantity. Moreover, its potential depends on various factors, such as the forest management strategies linked with ecological restrictions, the demand in the wood and energy markets, and the supply costs and subsidies in forestry. These factors are, in turn, influenced by conditions such as resource and energy policies, as well as the environment, the climate and the interrelated changes in both.

2.2.1 Forest management strategies and market situations

Forest management strategies and market situations have a great influence on wood fuel potentials. In the analysis of wood fuel potentials (Thees *et al.* 2020), the following forest management strategies were applied:

- Business as usual**, representing a continuous growing stock increase (CSI). This strategy reflects the current harvesting and management practices in Switzerland and can therefore be seen as a reference scenario. It leads to increasing growing stocks in all regions except

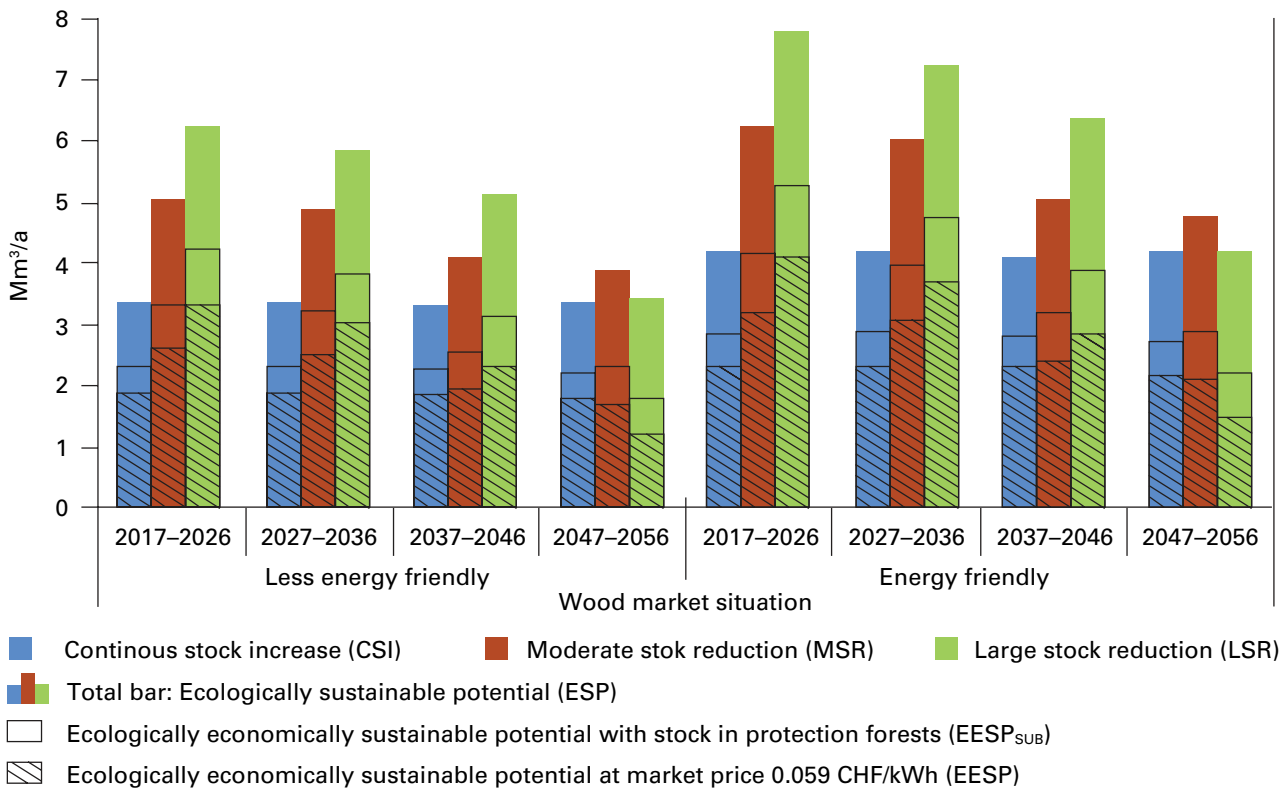

Figure 3: Sustainable wood fuel potentials from forests (as volumes [Mm³/a]) produced in each of four decades using three forest management scenarios (CSI, MSR, LSR) and two wood market situations (less energy friendly and more energy friendly) across all of Switzerland (Thees *et al.* 2020).

for the Central Plateau; on average, the stock currently amounts to 370 m³/ha.

- b. **Medium-intensity management**, representing a moderate stock reduction (MSR). This strategy targets growing stocks of 300–310 m³/ha until 2046 and is intended to accelerate growth.
- c. **High-intensity management**, representing a large stock reduction (LSR). This strategy accounts for a high demand for wood fuel from forests until 2046, leading to more frequent thinning and 40% shorter rotations, with target growing stocks of 250 m³/ha.

Averaged over the three forest management scenarios, the wood fuel potentials from forests were 22% greater in a more energy-friendly wood market situation than in a less energy-friendly one (Fig. 3). The latter led to greater material use. Whereas the business-as-usual management scenario (CSI) permitted the most constant supply over several decades, both **stock reduction scenarios produced greater cumulative total potentials**. Over the entire period, the stock reduction scenarios led to a 32% (MSR) or 52% (LSR) increase in ecologically sustainable potentials (ESPs) (8–16 PJ/a or 1.1–2.2 Mm³/a) compared with the business-as-usual management scenario CSI. When economic restrictions were considered as well, the more intensive management scenarios led to a 25% (MSR) or 41% (LSR) increase in the ecologically and economically sustainable potential with subsidies in protection forests (EESP-SUB) (4–9 PJ/a or 0.6–1.2 Mm³).

The more intensive forest management strategies showed a biomass surplus in the short- and mid-term (Fig. 3). **Following these strategies could offer additional potentials on a temporary basis during the energy transition phase.** In con-

trast to the large stock reduction (LSR) forest management strategy, however, the moderate stock reduction (MSR) strategy did not result in a considerable decline in the amount of wood fuel from forests expected in 2050. An interactive map on www.waldwissen.net allows canton-level calculations of the ecologically sustainable potential under different silvicultural and harvesting conditions (Erni *et al.* 2021).

2.2.2 Supply costs and revenues

Supply costs (harvesting, transportation and chipping) on the one hand and revenues for wood fuel on the other largely influence the sustainable potentials resulting from the different forest management scenarios. At current market prices of 0.059 CHF/kWh, 1.9 Mm³ of broadleaf wood fuel and 0.6 Mm³ of coniferous wood fuel could be mobilized per year (Fig. 4). Because of its higher energy content per unit volume, most broadleaf wood fuel could be produced at lower costs; the provision of conifer wood fuel is more expensive and more evenly distributed over all cost classes. At market prices below 0.059 CHF/kWh, broadleaves increasingly dominate wood fuel supplies, whereas the conifer portion increases when market prices exceed 0.08 CHF/kWh. **A price increase of 0.01 CHF/kWh from a reference price of 0.059 CHF/kWh would increase the available wood fuel by ~1 Mm³/a** (Thees *et al.* 2020).

Biomass transport represents a major share of the final cost and price of biomass use for energy, and it causes greenhouse gas (GHG) emissions. A techno-economic analysis of biomass transport (Schnorf *et al.* 2021) identified the most common transport chains from the supplier to the final con-

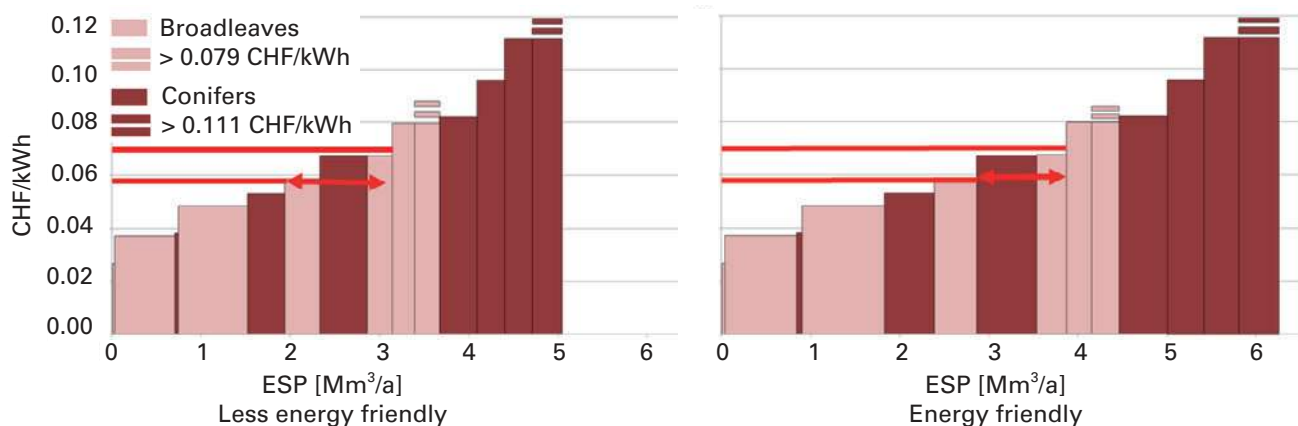

Figure 4: Effect of energy prices on annual wood fuel potentials from forests. The ecologically sustainable potential (ESP) between 2017 and 2026 is shown for the moderate stock reduction forest management scenario under a less energy-friendly (left) and a more energy-friendly (right) market situation. The width of the bars reflects the additional volume per cost class that would be available at a given market price. The red lines show the additional potential at a price increase of 0.01 CHF/kWh.

sumer. Transport distances to the final consumer are between 1 and 15 km for firewood (pieces of wood ready for burning) and between 5 and 30 km for woodchips. Woodchip transport is more efficient than firewood transport in terms of cost, energy balance and CO₂ emissions, except when highly professionalized firewood transporters are used. **In Switzerland, the main barrier to biomass transport is cost** rather than energy consumption by vehicles or CO₂ emissions.

2.2.3 Subsidies

The management of protection forests (up to 90% of the forested area in mountain regions) is subsidized in Switzerland to ensure minimal tending according to national guidelines (Losey 2013). Hence, **subsidies available for the management of protection forests increase the amount of available wood fuel**. Thees *et al.* (2020) found that energy amounts could be increased by an average of 25% and timber volumes by an average of 28% across the three management scenarios shown in Figure 3. The difference between the amounts of energy and the timber volumes reflects the conifer dominance in mountainous areas, as conifers have a lower energy content per unit volume. As expected, the largest relative increases resulting from subsidies in the quantity of wood fuel from forests occur in the Alpine region.

2.2.4 Regional differences

The **regional analyses** revealed contrasting results between Alpine and non-Alpine regions and **provide guidance as to which regions would benefit from investments to promote sustainable wood fuel use**. Economic constraints reduced absolute potentials of wood fuel in the Alpine regions to less than half of the ESP in the stock reduction scenarios and to slightly more than half in the CSI scenario. However, to a large extent, these potentials can only be mobilized in Alpine regions with the help of subsidies. In contrast, reductions in wood fuel potentials due to economic constraints were much smaller in the Jura and Central Plateau, where the terrain is more accessible and stands are composed of large broadleaf stocks. Therefore, these are the regions where strategic investments would be particularly advantageous. Even in the Jura and Central Plateau, however, the availability of additional wood fuel from forests is quite limited (e.g. MSR scenario over 2017–2026: Jura 2.7 PJ/a, Central Plateau 4.4 PJ/a).

Bioenergy hot- and coldspots were identified (Fig. 5) and compared with socio-economic characteristics (Mohr *et al.* 2019). This comprehensive description of the situation on a local level can help lead to the effective implementation of bioenergy. The **hotspots, representing a high potential of wood fuel from forests per unit area, lie in the north part of the country**, i.e. in the Central Plateau and the Jura region, while the **coldspots**

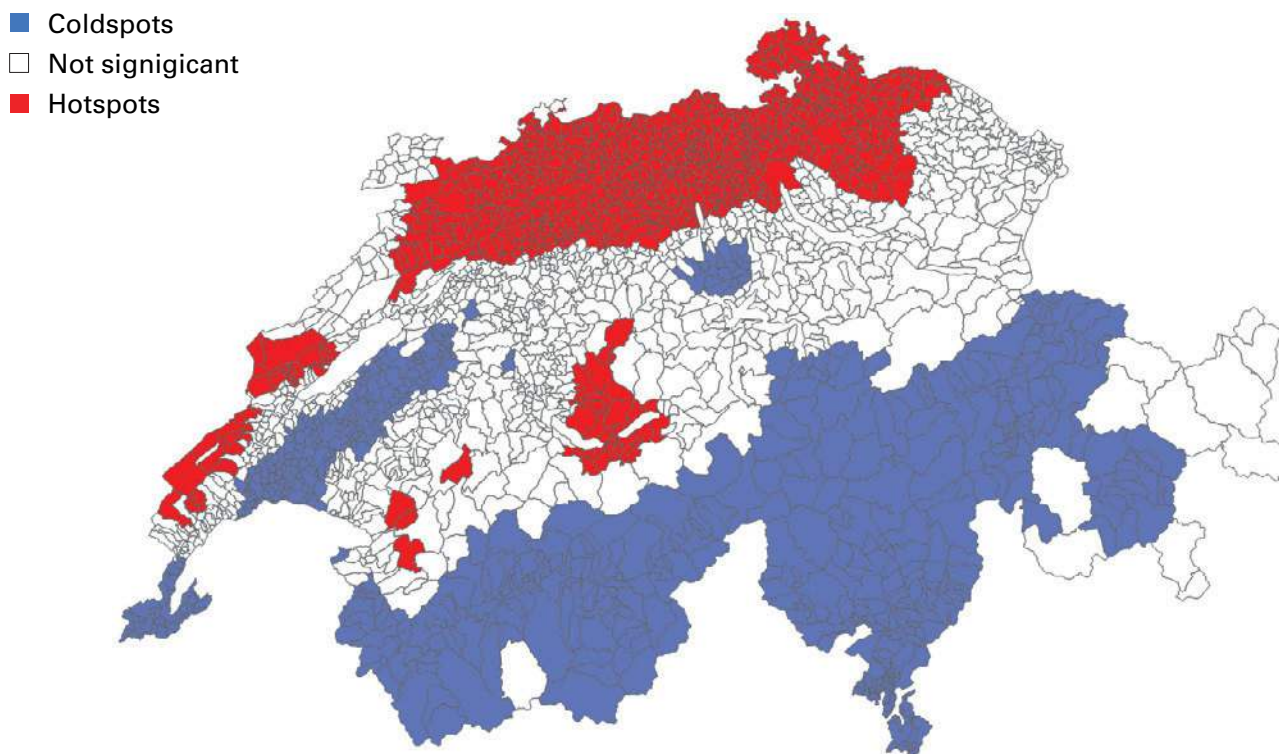

Figure 5: Hot- and coldspots in the sustainable potential per unit area of wood fuel from forests.

are located in the Alps. In high-elevation, steep and remote locations in the Alps, harvesting forest wood is often too costly, which results in lower sustainable resource potentials. Socio-economic properties, such as household income, political orientation, and population density, were found to differ strongly between hotspots and coldspots. The comparison shows correlation rather than causality, but it still highlights synergies between areas, and the knowledge gained from the analysis can be applied to projects in similar areas. For example, **the attitude of the population towards the energy transition is on average better in coldspots** than in hotspots. Thus, including the population more in the energy discussion could help to ensure that the most favorable spots for developing bioenergy have the support of the local population.

2.2.5 Opportunities and risks

Regarding opportunities, wood is a renewable resource and a unique biogenic carbon source that can be used in a wide variety of ways, both as material and as an energy source. Sequential and multiple uses, i.e. **cascading uses**, are possible, with energy use at the end of the chain. The repeated material use of the same wood is particularly efficient and saves resources. It offers ecological and economic benefits, such as GHG binding, carbon storage and use, creation of added value, support of the energy transition, and better integration of wood into the circular economy. The **storage capacity** of wood – standing in the forest or lying in stocks – is another important property; it makes wood resources flexible in their use, an especially valuable characteristic in the context of energy use. Furthermore, **wood – both as a raw material and as a product – stores carbon** and thus supports the aim to reduce CO₂ emissions (Thürig and Kaufmann 2008, 2010; Werner *et al.* 2010; Steubing 2013; Mehr *et al.* 2018). Wood has a **high carbon content** (ca. 50% on a dry mass basis, e.g. Diestel and Weimar 2014) and is hence suitable for the sustainable production of chemicals and fuels (Brethauer *et al.* 2021). Due to its **decentralized production**, wood is available throughout the country. Again, the largest share is produced in forests as an **important ecosystem service** of sustainable multifunctional forest management, i.e. forest wood is produced and harvested in an environmentally sound way. Wood production in forests and landscapes additionally creates jobs, representing an important area of employment in rural areas, and contributes to species conservation and biodiversity.

In terms of energy, wood can be used to generate several end-use forms: heat, electricity and

fuel. For example, regarding the winter electricity gap, electricity generation can be increased by using wood, or the electricity demand of heat pumps can be reduced by increasing the number of wood-fired heating systems. Due to wood's storability, there is considerable flexibility in the timing of its use for energy and it is suitable for sector coupling. In this respect, wood fuel can **compensate for fluctuating renewable energy forms**, such as wind or solar. Wood fuel is considered CO₂ neutral because no more CO₂ is emitted to the atmosphere during its combustion than was absorbed from the atmosphere during plant growth. This makes it **favorable as a substitute for fossil fuel**, whose use increases the total amount of carbon in the biosphere-atmosphere. Therefore, plant operators are not required to purchase emission allowances for emissions from biomass in EU emissions trading. Furthermore, wood- (and non-wood-) based bioenergy linked with carbon capture and storage (BECCS; see section 3.1, Fig. 7) is one of the technical options that can deliver negative emissions (IEA 2020).

In Central Europe, wood fuel from forests (thin or low-quality wood assortments) is usually a by-product of the harvesting of stem wood; nevertheless, wood fuel has become the main product in many Swiss forest enterprises (>50% of the assortments processed). This is also a consequence of unplanned harvesting after extreme events driven by climate change and of the migration of the pulp and paper industry. In forestry, the production of energy wood not only generates income from the material use of the wood, but also helps to re-finance the maintenance of forest stands and protect them against diseases caused by insects and fungi. **Recently and viewed globally, the use of wood fuel from forests is considered more critically.** Hundreds of scientists demand to completely stop the direct use of wood fuel from forests for climate protection reasons (Raven *et al.* 2021). However, according to the IEA (2020, 2021), these demands are based on misjudgments.. The IEA has attempted to dispel the misunderstandings regarding the use of forest biomass for energy as a climate protection strategy in a compact summary, but the debate is ongoing (Norton *et al.* 2021; Serman *et al.* 2022). In many cases, there is a lack of knowledge about sustainable forest management in Europe. For example, Schulze *et al.* (2021) stated, from a German point of view, that sustainable forest management and the associated material and energy use of the harvested wood would make a greater long-term contribution to climate protection than natural forest development without any wood use. Furthermore, Blair *et al.* (2021) showed that the supply chains of woody biomass from forests meet the UN sustainability goals, which also include aims other than CO₂ storage.

The results of such analyses of forest wood use are strongly dependent on the time as well as on the system boundaries and the differentiation of the analyses. Concerning the energy use, it is therefore relevant, for example, with regard to the climate effect

- whether, in addition to traditional combustion for heat generation, modern conversion technologies that generate not only heat but also electricity and fuels with high energy and CO₂ efficiency (see chapters 3 and 4) are taken into account;
- to which extent the different locations, tree species, rotation times, and strengths and frequencies of harvesting measures in Switzerland (and in Central Europe) are considered in a differentiated manner;
- to which extent the different proportions of harvested softwood and hardwood, that are used for energy (and not for material use, which is preferable from a CO₂ point of view), are taken into account.

There are **institutional limits** to short-term increases in energy wood harvesting. In Switzerland, there are about 245,000 small private forest owners who own 29% of the forest (average size 1.5 ha). The willingness of these forest owners to harvest (much) more on the short term or even any of their forest is often overestimated. Many forest owners do not behave in a purely economic way. In the case the smallest private forests, owners often do not consider their forest as a relevant source of income (so-called insignificance problem). Further, the municipalities, which are responsible for 50% of the forest area in Switzerland, often do not behave in a profit-oriented way for various reasons. **The ownership structure can strongly affect the amount and speed of wood use, and the effects of financial incentives are limited.** In addition, the harvesting capacity, especially the number of personnel devoted to harvesting may need to be greatly increased in the short term.

On the operational level, possible **environmental risks** of energy wood use in the forest are mainly related to overuse (but also underuse), as well as the use of brushwood, leaves and needles to an extent that it affects the nutrient balance of the forest soils. The cantonal Swiss Forestry Services monitor compliance with legal regulations and guarantee sustainable forest management in order to minimize these risks. Forestry certification systems, such as FSC and PEFC, pursue the same aim. On a higher level, there is a **risk of a reduced resource efficiency** as a result of the high proportion of energy wood use in the forest or the direct use of raw wood for energy purposes and the resulting underutilized opportunities for

cascading use. This allocation of the resource exacerbates competition with the material-utilizing wood industries (e.g. particle board production) on the procurement markets and may encourage their migration.

Possible **risks of a lack of economic efficiency** of energy wood use are related to the limited supply of wood fuel, its expensive provision in forests and fields, and the comparatively costly subsequent processes of conversion, waste gas purification, distribution and disposal. These risks can be countered by high-value energy use, for example covering peak demands by producing process heat for industry and generating high-value energy products such as aviation fuel. Possible **risks of an uncertain raw material supply** to the conversion plants are also important. However, in the case of energy wood, long-term supply contracts with forestry operations are possible, which help to lower these risks.

2.3 Future availability of wood fuel

According to model calculations (Erni *et al.* 2020), **the sustainable wood fuel potential can be expected to increase slightly until 2035 and then decrease slightly until 2050** (Fig. 6). Applying the business-as-usual forest management strategy (forest use < growth) results in a rather constant future sustainable potential of wood fuel. Related to the total sustainable woody biomass, alternative forest management strategies can be expected to result in larger shares (4–7%) of the annual gross energy consumption (primary energy) over the next 15 years (2020, 2035). The share of sustainable woody biomass compared with all sustainable biomass ranges from 42–64% by 2035 to 37–57% by 2050.

Another consideration in this context is that the politically desired convergence towards a **cascade and a circular economy** in Switzerland (FOEN, SFOE and SECO 2018) and Europe (e.g. EEA 2018; Husgafvel *et al.* 2018) **could temporarily lower wood fuel potentials** from forests and residues. Low-value wood assortments could be increasingly processed into wooden products such as insulating and packaging materials in efforts to avoid fossil raw materials, hence competing with energy use. Wood fuel potentials could also decrease if wood residues and waste wood from product processing become better integrated into (innovative) cascades and recycling. Later, when the wood is used more efficiently for materials, a shift from wood fuel towards waste wood can be expected (Erni *et al.* 2020). Wood fuel can also be expected to become uncompetitive and ultimately be replaced in the low-temperature heat market as heat pumps become more efficient.

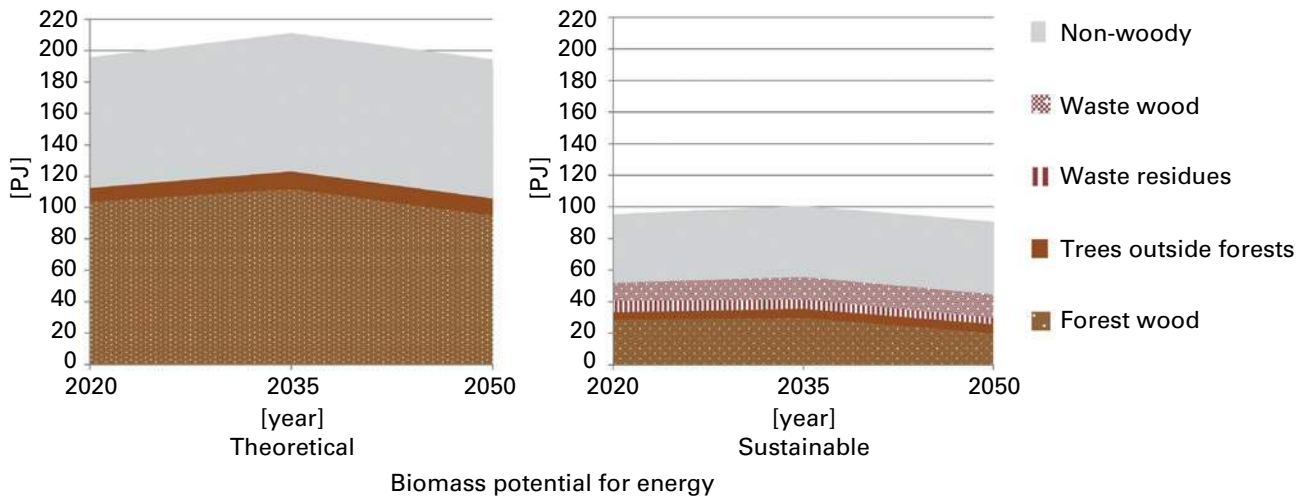

Figure 6: Annual theoretical (left) and sustainable (right) biomass potentials today and in the future. For wood fuel from forests, the figure refers to a medium-intensity forest management strategy equivalent to a moderate stock reduction and a less energy-wood-friendly market. In the theoretical potential, waste wood and wood residues are included in the original wood sources of forest wood and trees outside forests. Adapted from Burg *et al.* (2019) and Erni *et al.* (2020, Supplementary Material).

3 Technologies for using wood fuel

3.1 Overview

In contrast to other renewable energy sources, woody biomass can be used to generate a multitude of energy services. This variety may become crucial to the energy transition, as it renders the energy system more flexible. However, this flexibility goes hand in hand with complex conversion process chains and a broad, multidisciplinary research and development field for biomass conversion processes (Fig. 7). The following sections describe the **research contributions of SCCER BIOSWEET to the most important pathways for the conversion and use of woody biomass.**

The combustion of woody biomass or intermediates, as well as the energy carriers derived from it, enables direct electricity and heat production (see section 3.2). Combustion is therefore applied for combined heat and power production (CHP) or for dedicated heat production. In future, the latter will preferably be reserved to cover peak load demands (e.g. during the shortage of renewable electricity in winter) and for high-temperature process heat. The production of energy carriers increases flexibility with respect to the time and place of its use (see section 3.3 on the production of gaseous fuels and section 3.4 on the production of liquid fuels). Interestingly, fuel syntheses are

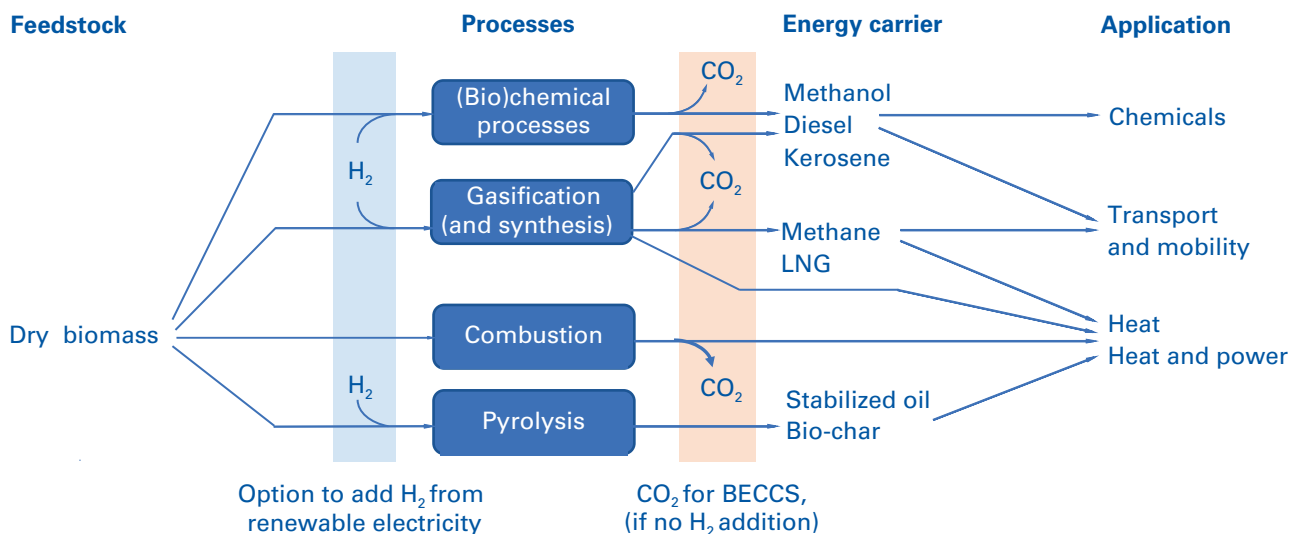

Figure 7: Overview of important conversion pathways of dry biomass (BECCS: bioenergy with carbon capture and storage, LNG: liquefied natural gas). Adapted from Schildhauer *et al.* (2021).

exothermic processes; hence, part of the initial energy content is released as waste heat, which can in turn be used to obtain higher overall efficiencies (see section 3.3.4). Furthermore, the oxygen content of woody biomass is higher than that of the important energy or fuels, i.e. oxygen has to be removed as either CO₂ or H₂O. This opens the possibility of renewable hydrogen addition (Power-to-X) to the synthesis steps, which increases the amount of energy carrier generated from a certain amount of biomass, or the downstream separation of CO₂, which could then be used for sequestration and thus negative carbon emissions. The production of liquid fuels could also facilitate a further conversion into chemicals for material use (see section 3.5 on biorefinery).

3.2 Electricity and heat production

3.2.1 Initial situation

Combustion of wood, the most commonly used dry biomass fuel, is widely applied today, mainly to provide heat for buildings, with a minor share for high-temperature process heat and for combined heat and power production. In the past decades, developments towards high efficiencies and reduced pollutant emissions resulted in a variety of technologies for different wood fuels and size ranges. For residential heating, log wood is used in manually operated devices for direct room heating in wood stoves (typically 5–15 kW) and for central heating in wood boilers (typically 15–70 kW).

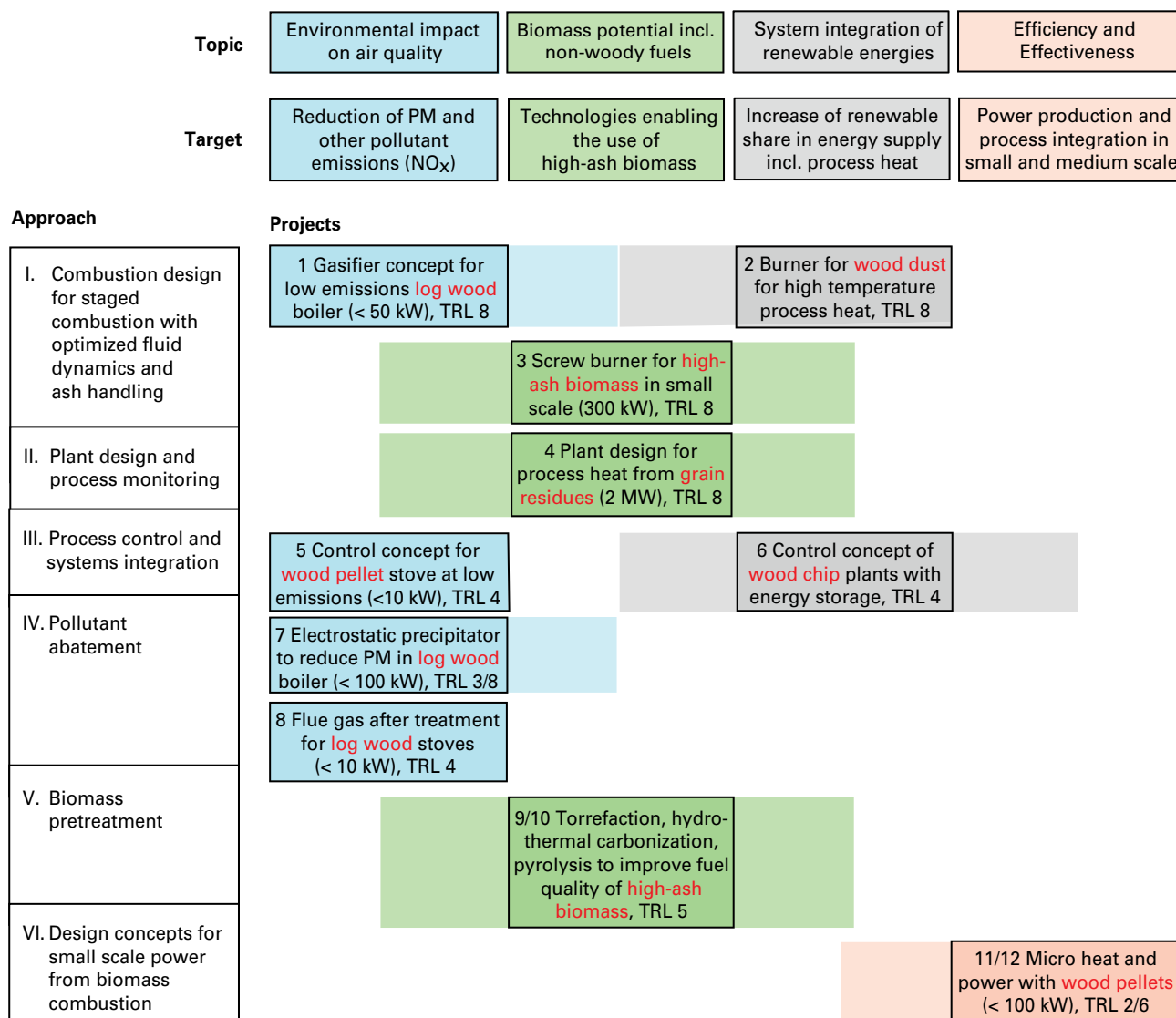

Figure 8: Innovation approaches followed in SCCER BIOSWEET projects in the field of combustion and combined heat and power. The colored shadows represent the overlapping topics of the projects. The projects are numbered 1–12 for orientation in the text. TRL: technology readiness level.

The latter are combined with a heat storage tank to enable uninterrupted combustion, avoiding high emissions due to load reduction. The use of log wood, however, declined over the past three decades, from approx. 25 PJ/a to 15 PJ/a, while automated wood combustion increased from less than 10 PJ/a to more than 30 PJ/a. In the size range from 200 kW to 10 MW, underfeed-stoker and moving-grate boilers are commonly used with woodchips and shredded wood residues for central heating and district heating. Additionally, wood pellets have been introduced into the market as a commodity fuel, enabling automated combustion systems at a small scale. On the other hand, for industrial-scale applications, fluidized bed combustion is used in a limited number of combustion plants >10 MW, enabling higher efficiency thanks to further improved combustion under conditions with minimized excess air. Although commercial systems are available for a broad size range, the following major challenges to economical and environmentally friendly use still exist, applying not only to wood, the most important biomass resource quantitatively, but also to some other non-woody biomass types:

- i. **Wood combustion is still a source of health-relevant aerosols** (Zotter *et al.* 2019), in particular from inappropriately operated small-scale systems (Nussbaumer 2017, 2020). However, over the last 30 years particulate matter emissions from wood combustion have decreased from 7,000 t/a to 2,000 t/a, even though the amount of energy wood used has increased from 3.2 to 5.6 Mm³ over the same period.
- ii. **Non-woody high-ash biomass resources** (e.g. dry agricultural residues) **are still mostly unused** because of technical challenges with its use for energy, which are mainly caused by inorganic fuel constituents such as ash and nitrogen.
- iii. **Integration of renewable energy sources into the energy system requires adaptations to match temporal imbalances**, e.g. the seasonal discrepancy of solar yield and energy demand can partly be compensated by the use of woody biomass as a storable energy carrier, while the wood-sun coupling could save scarce biomass in summer.
- iv. **Electrical power production from wood and other biomass**, e.g. to supplement solar power in winter, **has a low efficiency and high cost** for applications at the scale of interest for Switzerland (i.e. <100 MWe; Bauer *et al.* 2017).

In the framework of SCCER BIOSWEET, combustion research and technological developments aimed to create technical innovations addressing these four challenges and their related targets, as summarized in Figure 8. The overarching objective

was to maximize effectiveness in the use of the potential of wood and other solid biomass for energy production in the Swiss energy system while maintaining a low impact on the environment.

3.2.2 Innovation approaches

The **first innovation approach** comprised **combustion design** and the development of advanced combustion technologies, in particular by introducing **gasification concepts** (project 1: gasifier boiler) and **staged combustion** (project 2: wood dust burner [Fig. 9]; project 3: screw burner [Fig. 10]). In one development high-temperature process heat can be produced to increase the valorization compared with current applications in buildings (project 2), while in another approach measures for improved ash removal from the combustion section are applied to extend the range of applicable fuels to high-ash biomass in small- and medium-scale systems (project 3). As an additional benefit, combustion modeling, including computational fluid dynamics (CFD) and laser-based aerodynamic investigations, was developed and is now available for advancing the design of primary measures to reduce pollutant emissions (Winkler *et al.* 2018; Barroso *et al.* 2019a).

In the **second approach, plant design and process monitoring** were developed to provide process heat in the food processing chain using wheat grain residues (project 4). The process monitoring makes it possible to predict maintenance requirements and to minimize the use of fossil fuel consumption, thanks to minimized shutdowns of the biomass plant. In addition, the operation of the system for NO_x abatement is optimized to reduce pollutant emissions of NO_x and side products (Nussbaumer *et al.* 2019).

The **third approach** comprised developments and modeling for advanced **process control and integration of biomass systems**. The investigated applications covered the range from residential applications (project 5: FHNW 2019) to district heating networks, where combined heat and power production can optionally be applied to provide additional electricity (project 6: Schumacher *et al.* 2020).

In the **fourth approach**, secondary measures for **pollutant abatement for small-scale applications** were developed. The focus was on log wood combustion systems, which can cause increased emissions of particulate matter (PM). For central heating applications, an electrostatic precipitator (project 7) was integrated into a log wood boiler, which, compared with a downstream precipitator located in the exhaust system, enabled a reduction in the duration of limited separation efficiency during start-up and operation with a limited

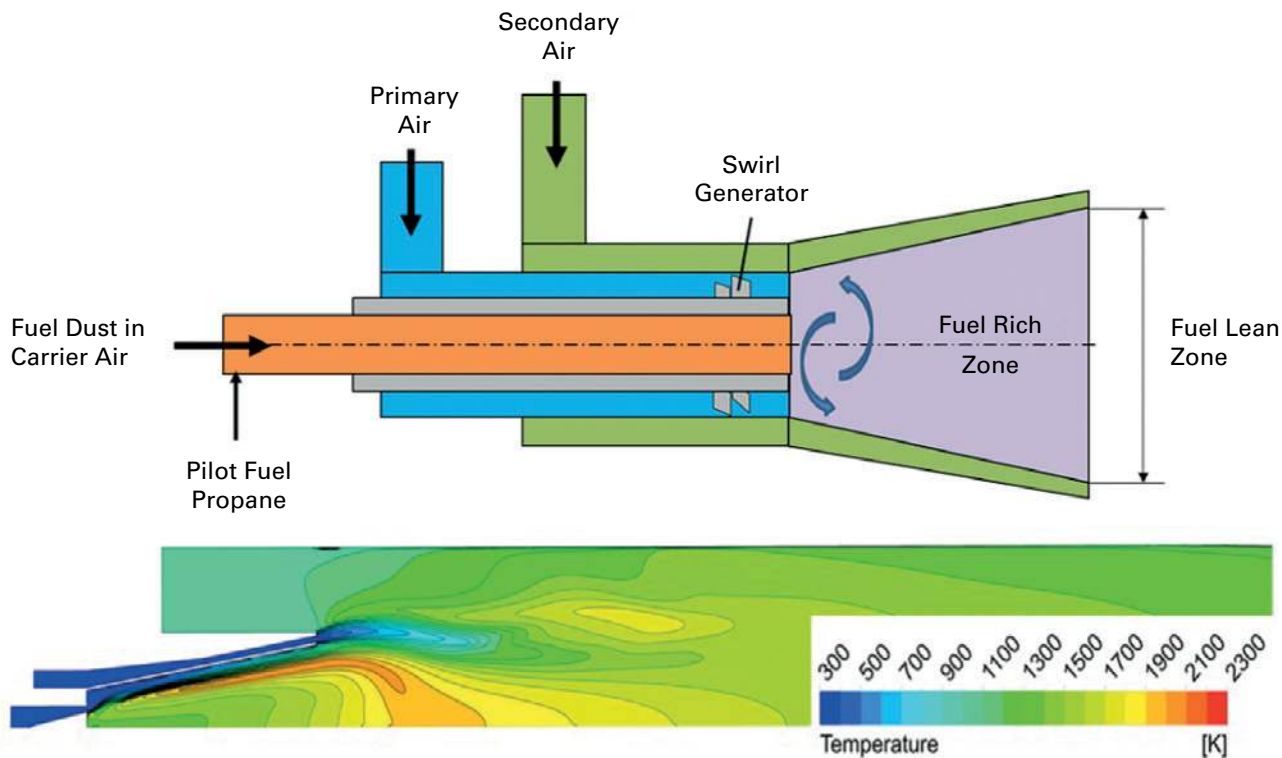

Figure 9: Swirl-stabilized burner for the staged combustion of pulverized fuels such as wood dust (Winkler *et al.* 2018). Above: burner design principle. Below: temperature profiles calculated from combustion modeling using computational fluid dynamics (CFD). This model was based on a Eulerian/Lagrangian approach and evolved from a model of pulverized coal combustion. A central recirculation zone was designed to be fuel-rich to reduce NO_x emissions; increasing swirl enhanced radial spreading of the fuel particles, which reduced CO emissions.

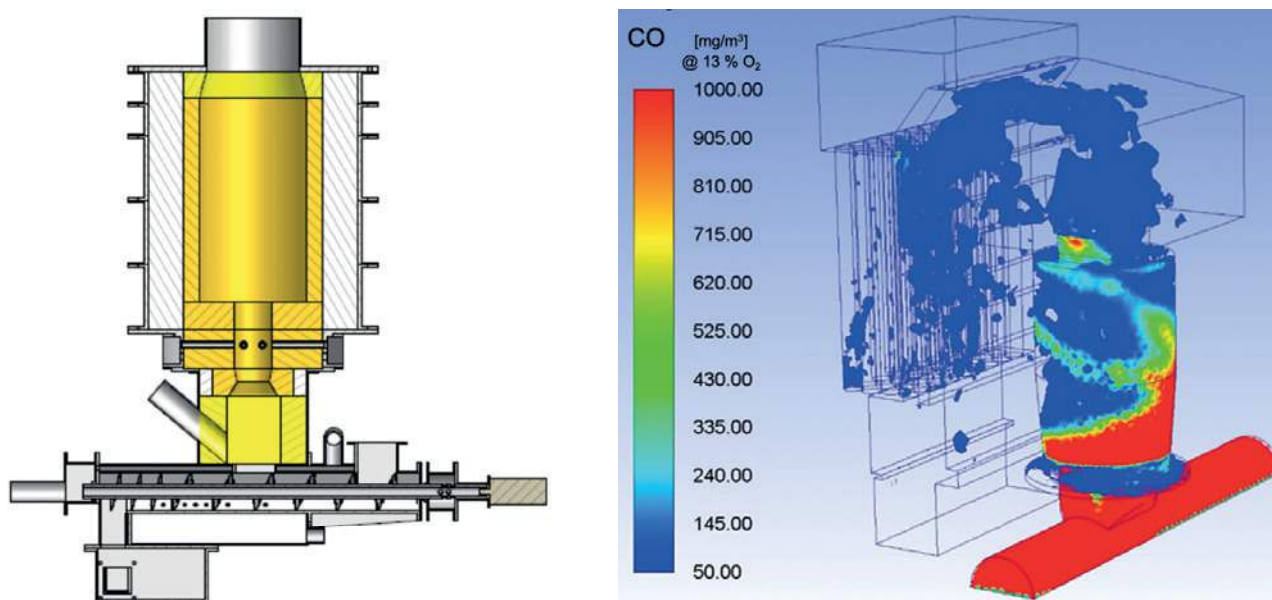

Figure 10: Screw burner for high-ash biomass fuels in applications of 100–300 kW (Barroso *et al.* 2019b). Left: the screw burner principle enables a continuous removal of the ash from the combustion zone to avoid ash melting and deposition, which disables the use of high-ash fuels in conventional small-scale boilers. Right: CO concentration shown as an example of the results from computational fluid dynamics modeling (Barroso *et al.* 2019c). Fluid dynamics modeling and experiments are applied to optimize air injection and combustion geometry to enable combustion with minimized excess air and consequently increased efficiency and to reduce pollutant emissions, in particular unburned carbonaceous compounds and nitrogen oxides (NO_x).

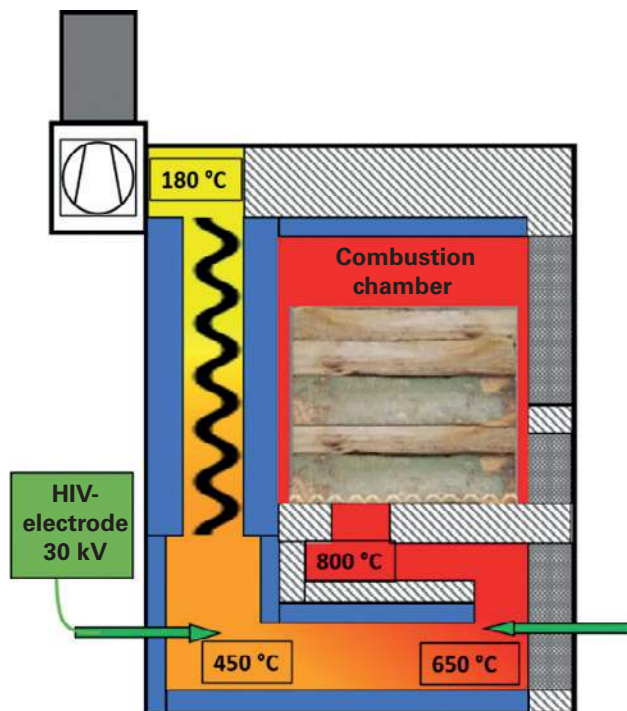

Figure 11: Log wood boiler with integrated electrostatic precipitator particle abatement. The high voltage (HV) electrode for electrically charging the particles is placed within the boiler, either at 450 °C or at 650 °C (green arrow right hand). This integration improves the overall particle removal performance and reduces costs.

flue gas temperature (Fig. 11; Wüest *et al.* 2019). Another option for particle removal from wood stoves employs flow-through trapping filters, similar to those used to abate diesel motor emissions. Designs for their use in log wood stoves, either for new installations or for retrofits, were evaluated in project 8 (Ropp *et al.* 2019). Although such filters offer the potential to achieve high particle removal efficiency, robust designs are required to deal with filter regeneration and blockage.

In the fifth approach, the **pretreatments** torrefaction, hydrothermal carbonization and pyrolysis were investigated as options **to increase the fuel quality of biomass residues** with undesired properties for combustion applications, such as low bulk density, high ash content, and limited durability (project 9, Michel 2017; project 10, Mehli *et al.* 2021). By applying such thermal treatments at a moderate temperature and reduced oxygen availability, low bulk density biomass can be converted into a solid product (e.g. biochar). A solid product has an increased carbon content and favorable properties as a commodity fuel (e.g. by grinding and pelletizing) or for applications in agriculture for soil improvement and CO₂ sequestration. However, legal regulations must be followed (FOAG 2020).

In the sixth approach, thermal design concepts for **power production in small-scale applications**

were developed (projects 11 and 12). For this purpose, a hot-air turbine was implemented to convert heat from wood combustion into electricity, thus enabling combined heat and power production in systems smaller than 100 kW (Schmid *et al.* 2014).

3.2.3 Contribution to the Swiss Energy Strategy 2050

Wood is a flexible renewable fuel that will play a major role in the Swiss energy transition because of its storage capacity, its flexibility in use, and its biogenic source of carbon. Combustion research contributes to overcoming the challenges of fully utilizing biomass potentials for energy applications and increasing the energy valorization of biomass. In particular, the **fuel stock can be extended** by broadening the applicable feedstock to high-ash fuels including non-woody biomass, thanks to specific developments reducing ash-related effects in combustion. In addition, the **environmental impact of biomass combustion can be greatly reduced** by primary measures such as advanced combustion design, staged combustion, and combustion control. Furthermore, secondary measures, such as particle removal, enable pollutant reduction in small-scale applications. Finally, the **contribution of biomass to the energy supply can be improved qualitatively**, through advanced systems integration reducing the temporal imbalance between renewable energy production and energy demand at large scales as well as through the option to produce power from biomass at small scales.

3.2.4 Future work

Although progress in combustion design has been achieved, there is still **considerable potential for improvement in biomass combustion devices** regarding both **efficiency** (e.g. including heat recovery from condensation) and **pollutant emissions** (especially regarding particulate matter (PM) and nitrogen oxides (NO_x), which will become more important with a broader use of high-ash biomass fuels). In addition, **secondary measures need to be developed further to improve reliability, reduce costs, and avoid side-products** (e.g. from NO_x abatement). For small- and medium-scale applications, flue gas cleaning devices should be integrated into the combustion and heat transfer system to reduce costs and improve the conditions for their operation and maintenance.

Process integration, including control concepts, the smart use of sensors, and thermal energy storage for heating plants and for CHP applications, **needs to be improved further to ensure**

optimum conditions at varying loads. For a sustainable energy system, energy on-demand, thus independence from seasonal or daily fluctuations, is an important need. Today, energy-on-demand is secured by fossil fuels, but they could potentially be replaced by biomass if appropriate measures are developed and available. In addition, it is advantageous to implement energy grids, which can bundle various energy carriers. In such grids, **biomass could become a backup system to complement fluctuating solar and wind energy.** Due to the need of rapid load changes, this would result in increased requirements for biomass conversion systems and their control concepts. For this purpose, **biomass heat and power systems could be combined with fast thermal energy storage (TES),** thus becoming a new line of research along with further improvements in systems integration and control concepts.

To increase the effectiveness of biomass in the energy system, a strong focus should be placed on technologies that provide (high-temperature) process heat instead of low-temperature heat for buildings, as well as systems that provide electricity combined with heat as a side product to balance fluctuating renewable energies. Hence, both **technologies for process heat production and processes for power production with higher electrical efficiencies should be targeted and developed.**

With the increasing use of woody biomass as an energy source, the appropriate disposal of its ashes is becoming more and more important. Therefore, specific disposal routes for ashes from biomass will be needed in the future to increase the valorization of inorganic biomass constituents and to avoid high disposal costs.

3.3 Production of gaseous fuels

While wood can be immediately used to cover energy requirements, especially by combustion for heat or by combustion-based electricity production, the conversion of wood (residues) to fuels is advantageous for several reasons. An infrastructure exists for gaseous fuels that allows their transport and storage, and highly efficient utilization technologies can be applied. There are multiple pathways for gaseous fuel production from biogenic feedstock. In anaerobic digesters, wet biomass types, such as agricultural residues, green waste and sewage sludge, can be converted into a raw biogas, a mixture of 50–65% methane (CH₄) and carbon dioxide (CO₂). **Due to the large amount of lignin in wood, woody biomass cannot be converted into biogas in anaerobic digesters. Instead, thermochemical processes, such as gasification, are applied to convert wood into a gaseous fuel.** In principle, all wood qualities can

be gasified, i.e. pellets, productoin residues and forest chips. However, regulations with respect to waste treatment set limitations, e.g. regarding the use of painted or impregnated wood.

3.3.1 Producing hydrogen from wood

In the raw producer gas of **high-temperature gasifiers**, e.g. oxygen-blown entrained flow gasifiers at 1200°C, only traces of compounds other than CO and hydrogen occur. This is an advantage if hydrogen is the targeted molecule and it can be distributed and stored efficiently. In this case, simple gas cleaning (mainly H₂S adsorption) followed by a water-gas shift reaction, CO₂ separation and drying leads to the production of pure hydrogen (Tock *et al.* 2012; Antonini *et al.* 2021), as shown by studies involving SCCER BIOSWEET researchers. The relatively **high specific costs of the high-temperature equipment mean that large units are required (>250 MW, i.e. ca. 60 t/h air-dried woodchips)** to benefit from the economy of scale. In the biomass field, large units are penalized by increased logistics costs arising from the transport of larger wood volumes. This, together with the absence of a hydrogen infrastructure (e.g. grid) to distribute the large amounts of hydrogen produced, have impeded commercial attempts to produce hydrogen from wood. **However, as wood conversion into hydrogen is inherently connected to the production of biogenic CO₂, it contributes to the aim of reaching net zero emissions;** if there is corresponding remuneration, this could improve the economic feasibility of this option in the future.

3.3.2 Producing methane from wood

Compared with the conversion into hydrogen, the situation is different for the production of renewable CH₄ from wood (Gassner *et al.* 2012; Schildhauer 2018). **Low-temperature dual fluidized bed gasification (~850°C) is economically favorable at small and intermediate scales** and produces a gas with a CH₄ content of up to 10 vol.%, which is beneficial for the overall process chain efficiency towards renewable CH₄ (Heyne *et al.* 2016). The most suitable example of a low-temperature gasifier for the production of renewable gas is the aliothermal dual fluidized bed (DFB) gasifier (Bajohr *et al.* 2014; Heyne *et al.* 2016). Due to the use of steam as a gasification agent, a DFB gasifier delivers a hydrogen-rich producer gas. The heat for the endothermic gasification is produced in a separate combustion reactor (around 900°C) to which the bed material and unburnt char are sent. The heated bed material (olivine) is fed back into the

gasification chamber (820–850°C). In this gasifier type, in parallel to CH₄ production, higher hydrocarbons such as ethane, ethylene, acetylene and aromatics (especially benzene) are formed (Heyne *et al.* 2016), accompanied by further trace components such as tars and organic sulfur species. Appropriate gas cleaning and gas conditioning are required before the raw producer gas can be converted, in a methanation reactor, into a gas mixture similar to biogas mainly composed of CH₄, CO₂ and a few percent of hydrogen, as shown by SCCER BIOSWEET researchers. Final gas upgrading by amine washers, drying and membranes is needed to recycle unconverted hydrogen and to yield injectable bio-methane. Further purifying of the CO₂ off-gases can provide biogenic carbon that can be sequestered to produce negative emissions (Gassner *et al.* 2009). In Power-to-Gas applications, renewable hydrogen could be added to convert the CO₂ fraction into additional CH₄ by integrating an electrolyzer into the process. In this case, hydrogen would be fed, together with the cleaned producer gas, into a slightly larger methanation reactor (Gassner *et al.* 2008; Bajohr *et al.* 2014; Teske 2014; Leimert *et al.* 2018). For wood applications, studies within SCCER BIOSWEET suggest that the production of methane can be doubled with a marginal efficiency of nearly 80% for the injected electrical power. Moreover, the Power-to-Gas option can, if operated in times of low prices of renewable electricity, be complemented with the negative emissions effect of CO₂ capture and sequestration, when no renewable hydrogen is available (Moioli and Schildhauer 2022, 2021).

3.3.3 Reactor and process concepts for producing methane from wood

Processes for producing CH₄ from wood have been developed by several consortia up to the pilot and industrial demonstration scale. The various methanation synthesis steps solve the challenges of the strongly exothermal and equilibrium-limited methanation reaction: the produced heat has to be removed and used efficiently within the process chain in order to overcome the limitations of thermodynamics. The two main reactor concepts developed and tested so far for the methanation of wood gas are: (i) adiabatic fixed bed reactors in series with intermittent and recycle cooling; and (ii) fluidized bed reactors, which were intensively investigated within SCCER BIOSWEET.

The **adiabatic fixed bed reactor** concept is state-of-the-art in coal-to-SNG (synthetic natural gas) processes and was chosen by the Gothenburg Biogas project (GoBiGas, TRL 8 demo plant) in Sweden (Held 2016; Schildhauer 2018) and the

Energy Research Centre (TNO-ECN, TRL 5 pilot plant) in the Netherlands (Rabou and Bos 2012; Rabou *et al.* 2016). Adiabatic fixed bed reactors consist of large vessels that are filled with catalyst particles. The exothermic reaction causes the temperature to rise, which in turn further increases reaction rates until the reactor reaches thermodynamic equilibrium. This reactor concept accepts hotspot formation due to the thermal run-away and limits its extent by recirculating cooled reactor effluent gas and/or adding steam until a level is reached that is acceptable for the specific catalyst (Schildhauer and Biollaz 2015; Schildhauer 2016). The first reactor does not reach full conversion, so the effluent gas must be cooled and fed into a series of further adiabatic reactors to reach full conversion (Schildhauer 2016). Due to the hotspot in the first reactor, aromatic compounds, such as benzene and other unsaturated species (ethylene and acetylene), must be removed or converted upstream to avoid irreversible catalyst deactivation by carbon deposition within the hot zones of the reactor.

To overcome these limitations and simplify the methanation process, and especially to minimize the number of reactors, **cooled methanation reactors were further developed** within SCCER BIOSWEET. Moving the catalyst particles in a **gas-solid fluidized bed** spreads the heat produced by the exothermic reactions over a large portion of the reactor, which strongly increases the usable heat transfer area. Moreover, the movement of the catalyst particles usually increases the heat transfer to the cooling surfaces through turbulence effects. This enables close-to-isothermal operation and helps to avoid catalyst deactivation by coke formation. As consequence, a considerable level of unsaturated hydrocarbons in the gasification gas is acceptable, which simplifies the gas cleaning process.

While fluidized bed methanation was already developed up to the demonstration scale (20 MW) for the coal-to-SNG process in the late 1970s (Comflux process; Schildhauer 2016), its use for **converting wood gas to methane** has been investigated by the Paul Scherrer Institute (PSI) for about 20 years and continues to be studied. Laboratory experiments and long-duration tests at TRL 5 were conducted to help develop a 1 MW pilot and demonstration unit (PDU, i.e. TRL 7) in Güssing (Austria) within the European Union project BIOSNG. The PDU demonstrated the complete process chain from wood to SNG, including DFB gasification, gas cleaning, fluidized bed methanation, and gas purification, at half commercial scale. Meanwhile, other research groups have investigated fluidized bed methanation, e.g. in the framework of the French GAYA project (GAYA 2021). Within SCCER BIOSWEET, the application of



Figure 12: SCCER BIOSWEET pilot plant (TRL 6) used to study the effects of pressure (up to 10 bar), gas velocities and particle size on the available mass transfer area in the fluidized bed methanation reactor (Photo: PSI). This knowledge can be used to improve the models used for reactor optimization and process simulations. The reactor simulations will be validated by experiments in this plant.

this reactor type within Power-to-Gas applications was investigated in modeling/simulation studies and in experiments up to TRL 5. To expand the knowledge base, required for safe applications at larger scales, the fluid dynamics in the reactor, especially the heat transfer, the mixing process, and the available mass transfer interfaces, were studied in a TRL 6 pilot plant to understand the influence of gas velocities, catalyst particle size and pressure (Fig. 12).

The GoBiGas project (Sweden) and the developments at TNO-ECN (The Netherlands) targeted commercial plants at the scale of 100 MW or more, which require large-scale wood logistics based on ship transport, with partial importing (if

possible). Therefore, relatively complex technology can be applied if the specific costs decrease during scale-up, simply due to scaling effects. Biomethane plants far from coasts and harbors, e.g. in Switzerland and other continental parts of Europe, cannot rely on large-scale wood logistics. In these areas, scales of 1–30 MW thermal input (about 0.25–8 t/h of air-dried wood) are more realistic and were therefore targeted within SCCER BIOSWEET. At such scales, the specific capital costs of fixed bed methanation processes, including their complex gas cleaning steps, could be prohibitive. A pre-engineering study (CTU AG 2014) showed that **important process simplifications are possible with the more robust fluidized bed methanation, allowing a substantial decrease in the specific capital costs.**

Today, the value added by producing renewable methane from wood residues is slightly too low for a wood-to-SNG plant to be economically feasible under current market conditions. **The option to use renewable hydrogen to flexibly convert biogenic CO₂ from the process into additional biomethane (especially in summer, when electricity production from photovoltaics is high) or an incentive for sequestering the CO₂ for negative emissions (e.g. in winter, when renewable electricity is expensive) will open further revenue possibilities.** Moreover, an increasing demand for renewable fuels (goal of “net zero” by 2050) and the limited options for importing renewable fuels could greatly improve the attractiveness of using wood as a flexible energy source and using the biogenic CO₂ within biomass-based processes as feedstock for fuels and chemicals.

3.3.4 Combined heat and fuel production

The conversion of dry wood into synthetic natural gas has an efficiency of around 65% (calculated as lower heating value), and the remaining 35% is theoretically available as heat. With a proper process design, 40% of this heat is available at a temperature high enough to replace an industrial boiler, which allows a combined heat and fuel production. This concept can also integrate Power-to-Gas production by electrolysis and alternating CO₂ capture and sequestration. The SCCER BIOSWEET has shown that this way combined heat and fuel production becomes a **negative emissions technology** that contributes to renewable energy management and industry decarbonization (Celebi *et al.* 2019). It was shown in the SCCER BIOSWEET program that **the allocation of wood to a combined heat and fuel production is particularly advantageous compared to direct wood combustion.** When considering an industrial oil boiler as a reference, using wood in an

industrial boiler substitutes 0.3 kg fossil CO₂/kg of biogenic CO₂, while the combined heat and fuel production with Power-to-Gas integration has a 2.5 to 3 times greater substitution effect for the same amount of wood (Celebi *et al.* 2019).

3.4 Production of liquid fuels

3.4.1 Importance of liquid fuels

Growing concerns about the extraction and use of fossil resources have led society to seek renewable alternatives to liquid fuels. Renewable electricity is increasingly being envisioned as a replacement for several current uses of fossil fuels. However, a number of energy applications, especially those related to mobility and transport, must be disconnected from the main energy grids (electricity or gas) and therefore need efficient energy storage with high energy densities that, as of yet, can only be achieved by liquid fuels. This includes powering aviation and certain long-haul ship transport, where batteries have not yet approached the required energy density and thus liquid fuels, probably carbon-based, will probably be required in the medium to long term. Given that lignocellulosic biomass is the largest source of biogenic carbon on the planet, it is an attractive feedstock for these specialty transportation fuels.

Although lignocellulosic biomass shows promise in liquid fuel applications, major challenges remain for the integration of biofuels into the transportation industry, especially aviation. For fast and seamless integration into the current supply chain, drop-in biofuels are most suitable (van Dyk *et al.* 2019) because they are “liquid bio-hydrocarbons that are functionally equivalent to petroleum fuels and fully compatible with existing petroleum refining and distribution infrastructure” (IEA Bioenergy Task 39, 2019). Today, the dominant feedstocks for such drop-in biofuels are lipids, such as plant oils or waste oils from cooking, and their production has reached a commercial scale. However, the costs, the limited availability, and the often unsustainable production of these feedstocks are major challenges that are unlikely to allow large expansion of the technology. Thus, a variety of processing routes based on lignocellulose are under development. These can be divided into: (i) untargeted approaches that largely rely on numerous parallel and subsequent reactions, which include several thermochemical approaches; and (ii) targeted approaches, which rely on specific reaction pathways for each component of biomass, which includes biochemical and hybrid approaches.

3.4.2 Thermochemical conversion of biomass into liquid

The two dominating thermochemical approaches for liquid fuel production from biomass are gasification and liquefaction. Both are untargeted approaches that involve the rapid transformation of biomass through numerous reactions, starting from the main components of lignocellulosic biomass: cellulose, hemicellulose and lignin. **In the gasification route,** biomass is converted into synthesis gas (see section 3.3), which is a relatively uniform product because the numerous reactions involved almost always lead to the thermodynamically favored gaseous products. This initial process is followed by thorough cleaning of the synthesis gas and can be followed by catalytic conversion into liquid hydrocarbons, either by the Fischer-Tropsch process (which then usually requires additional hydrotreating to make hydrocarbons in the fuel range; Peduzzi *et al.* 2018) or by the catalytic synthesis of methanol or dimethyl ether (Peduzzi *et al.* 2013). The cleaning of the synthesis gas is performed to avoid poisoning of the Fischer-Tropsch catalysts, which is much more challenging, and thus more expensive, compared with similar thermochemical conversion processes of fossil feedstocks. **The liquefaction processes** include fast pyrolysis, catalytic pyrolysis and hydrothermal liquefaction, all of which require a second upgrading step of the derived bio-oil to upgrade the resulting mixture of often partially oxygenated molecules to the biofuel product. All of these routes remain unselective and prone to catalyst stability issues. Within SCCER BIOSWEET, the first step in converting solid biomass using hydrothermal liquefaction was studied. Cellulose, hemicellulose and lignin are broken down in hot pressurized water by hydrolysis. Because this step is slow and governs the production rate of the bio-oil, a new catalyst was developed. It is based on sulfonated carbon and a ball-milling pretreatment of the wood in the presence of the catalyst (Scholz *et al.* 2018, 2019).

3.4.3 Biochemical routes to liquid fuels from biomass

In biochemical processes under ambient conditions, biomass carbohydrate polymers are converted into the desired products by enzymes and microorganisms. While ethanol (which can be blended into gasoline or used as biofuel in adapted engines) has been produced biochemically at demonstration scale by companies such as Clariant, the direct production of jet or diesel drop-in fuels from biomass-derived sugars is much more challenging. Their microbial production requires

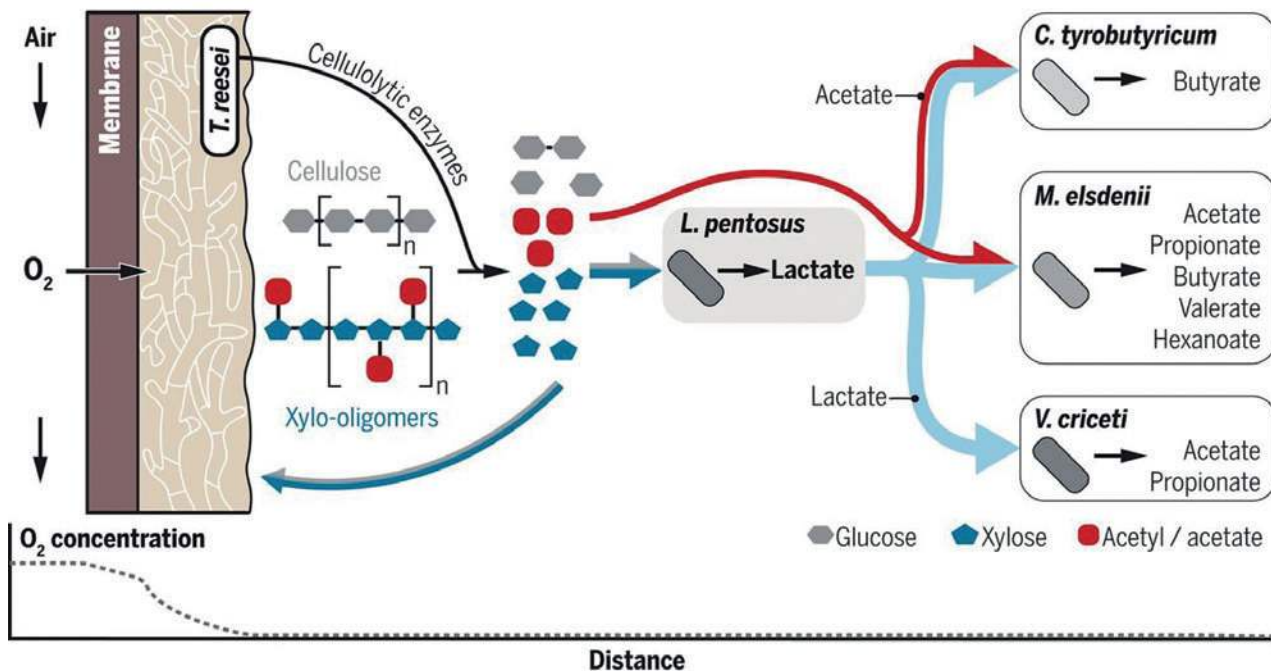

Figure 13: The lactate platform enables the consolidated bioprocessing of lignocellulosic polysaccharides and acetate into several products including carboxylic acids. Adapted from Shahab *et al.* (2020).

sophisticated genetically engineered microorganisms and is hampered by very low product yields and concentrations. In the framework of SCCER BIOSWEET, and with additional funding from the Swiss National Science Foundation NRP 70, a **hybrid pathway consisting of the biochemical conversion of the carbohydrates into carboxylic acids and the catalytic conversion of the acids into hydrocarbons** was developed.

In the first stage of this process, steam-pretreated beech wood was converted by an adaptable, artificial microbial consortium into different carboxylic acids as final products in a process termed the “lactate platform.” Thanks to this platform, it is now possible to convert the different sugars contained in the biomass first into lactic acid, as a common intermediate product, and then into the target acid by selecting the corresponding lactic-acid-consuming strain (Fig. 13; Shahab *et al.* 2020).

In the second stage, catalytic processes transform the wood-based carboxylic acids into aircraft fuels and α -olefins, which are among the most important basic materials in the chemical production of plastics and chemical intermediates (Rozmysłowicz *et al.* 2019). Cost estimates based on these first laboratory-scale experiments show that aircraft fuels produced with this technology would be twice as expensive as fossil fuels on the market. The elevated cost compared with fossil fuels is also a hurdle for other more mature hybrid processes, such as LanzaTech’s ethanol or Gevo’s isobutanol-to-jet, but they are nonetheless actively pursued, and the products have received

certification by the ASTM (Geleynse *et al.* 2018). In these hybrid processes, the intermediate products ethanol and isobutanol are produced from lignocellulose in a biochemical process, while the secondary conversion is a catalytic process. As the biochemical process takes place in aqueous solutions, the presence of water in the lignocellulosic feedstock is not an issue. Furthermore, microorganisms are typically only partly sensitive and can be adapted to substances introduced from low-quality feedstocks. Prior to the catalytic conversion, the intermediates can be partly purified by common processes, such as distillation, to avoid poisoning of the catalyst.

In parallel, efforts are being made to expand hybrid approaches to exploit lignin, the third major fraction of biomass for the production of liquid fuels. In theory, this fraction is very attractive for liquid fuel production, as its aromatic structure resembles crude oil structures much more closely than do the structures of carbohydrate fractions in biomass. This structure also makes lignin the most energy dense of the three main biomass fractions. In practice, however, lignin exploitation has been incredibly challenging. Lignin’s structure and reactivity are the main impediments to its exploitation. This biopolymer tends to rapidly condense during the initial biomass fractionation that is the first step in most targeted biomass transformations, including the biochemical and hybrid approaches described above. This leads to a lignin fraction that is highly recalcitrant to degradation and difficult to convert into a liquid fuel. In the framework of SCCER BIOSWEET,

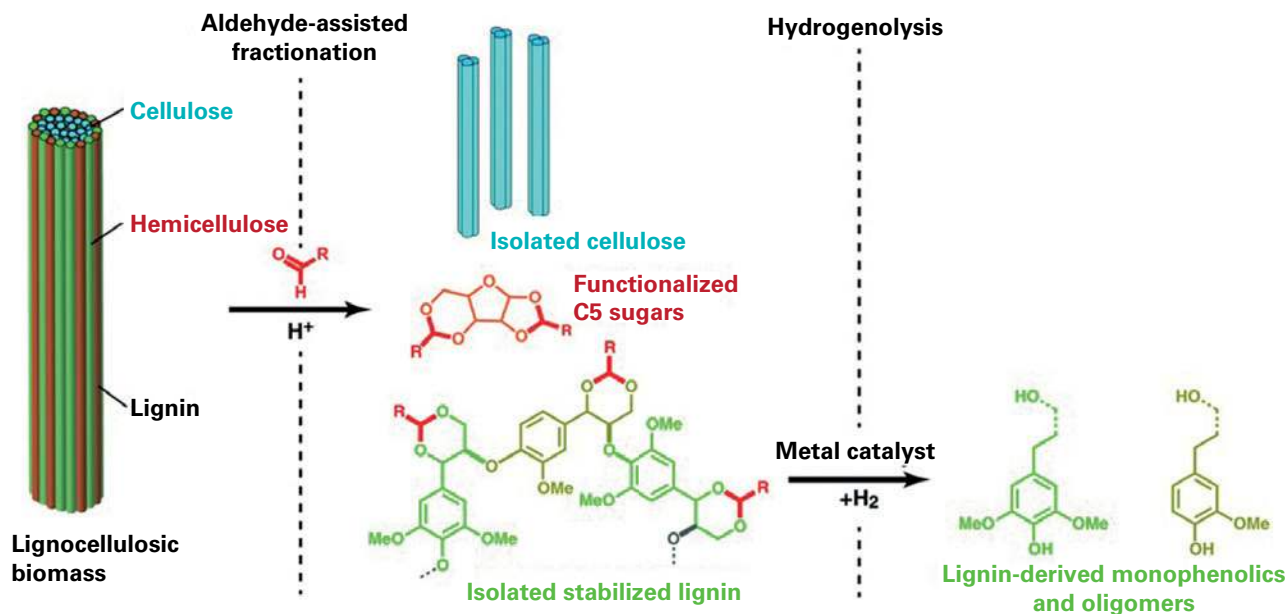

Figure 14: Overview of the aldehyde assisted fractionation (AAF) process, which produces a depolymerizable lignin fraction that can be used to produce monoaromatics from lignin at near theoretical yields based on ether cleavage (about 40 wt% of the lignin). Adapted from Abu-Omar *et al.* (2021).

aldehyde-assisted fractionation (AAF) was developed, which functionalizes the lignin with aldehydes and largely prevents condensation (Fig. 14; Shuai *et al.* 2016; Amiri *et al.* 2019). This process yields a lignin fraction that can be converted into monophenolic and oligomeric compounds, which can easily be valorized as an energy-dense liquid aromatic mixture with hydrocarbons similar to those found in jet fuel fractions (Du *et al.* 2018). This complements the reductive catalytic fractionation approaches developed by others, which yield similar results to AAF in terms of lignin but involve putting the catalyst in direct contact with the biomass (Questell-Santiago *et al.* 2020), which creates important separation issues that have yet to be solved. The opportunity provided by AAF to deconstruct lignin has led to the creation of an EPFL spin-off (Bloom Biorenewables Ltd), which is seeking to commercialize lignin-derived molecules, including those relevant for fuels. This spin-off is almost entirely based on research developed within the SCCER BIOSWEET program. Current efforts are at the demonstration stage.

3.4.4 Outlook

Overall, several pathways exist to make blendable fuel fractions from lignocellulosic biomass. In particular, hybrid solutions, including those developed within SCCER BIOSWEET, offer pathways to simultaneously valorize all the important fractions of lignocellulosic biomass with high selectivity,

which could maximize the energy recovered from biomass. However, all these technologies are immature (TRL 5 to 7) and are competing with well-established petrochemical processes that have benefited from over 100 years of development and optimization. **The continued support from the government to create a favorable development framework, as well as financial incentives, will be essential** to bring these technologies to market and offer a pathway to defossilize challenging transportation sectors, including the aviation industry.

3.5 Biorefinery: integrated approaches for wood conversion

Thermochemical conversion routes into liquid fuel are typically exothermic at higher temperatures, while biochemical routes are endothermic at much lower temperatures. The thermochemical production of liquid fuel therefore has to be assessed in combined heat and fuel configurations. The integration of thermochemical, biochemical and catalytic routes is a defining feature of biorefineries that convert wood resources into different biogenic chemical and fuel products (Brethauer *et al.* 2021). **The optimal biorefinery design would therefore target the production of high-value products (polymers, fine chemicals, pulps) while maximizing the conversion of biogenic carbon into a storable and easy-to-distribute energy vector** (Celebi *et al.* 2017). Similar to the production

of gaseous fuel, the production of liquid fuel involves the integration of electrolysis with a marginal efficiency of more than 90% of the lower heat value required to convert fuel to electricity (Peduzzi *et al.* 2018). In the biorefinery approach, the produced hydrogen would be used not only

as a renewable energy carrier but also as a building block for chemical products. In addition, CO₂ is a by-product of liquid fuel production, so the process can potentially produce negative emissions through the sequestration of biogenic carbon.

4 The role of woody biomass in the energy system

Building on the descriptions of wood availability in Switzerland (chapter 2) and the various possible technologies for energy wood use (chapter 3), the optimal use of this limited resource is now discussed from a systemic, an environmental, and an economic perspective. From the systemic perspective, the total energy demand in Switzerland for various services and the potentially available non-fossil replacements are analyzed to derive meaningful purposes for the use of wood.

4.1 Material or energy use?

As a multi-purpose and limited resource, wood should be used in a way that aims to enhance the environmental and socio-economic benefits from production through consumption. Saving fossil resources, increasing resource efficiency, and reducing CO₂ emissions play particularly important roles here. In this respect, **it is important that the wood is used materially** (e.g. for construction timber and insulation materials) to the greatest possible extent and preferably in a cascade, i.e. several times in succession for material use and only at the end for energy. This applies, in principle, to all types of woody biomass including waste wood. It is often forgotten, however, that residual wood accumulates along the entire processing chain in substantial quantities, e.g. in sawmills, joineries and furniture factories. This wood is almost exclusively energy wood of low supply cost and high quality (dry and free from mineral impurities). This means that energy wood does not only occur “at the end” of the process chain (as waste wood), thanks to cascade utilization.

In Switzerland, the quantitatively important forest wood fuel is usually a by-product of harvesting and processing stem wood and industrial wood, in that there are always some parts of a tree that cannot be used as material, for technical and/or economic reasons. Mehr *et al.* (2018) indicated that multiple cascading of wood in Switzerland could decrease environmental impacts: over the modeled 200-year horizon, total systemic emissions reductions relative to single cascading (i.e. all waste wood is directly incinerated) were between 35–59 Mt CO₂-eq. and 43–63 kt PM₁₀-eq.

Which other products are substituted during the cascade and how completely and efficiently wood can be used for energy production in the end are both relevant points. Additionally, it is more important to increase the use of primary wood under the current underuse of the resource (Suter *et al.* 2017). The factors driving the environmental impacts of future wood use scenarios have been found to be waste wood processing efficiency, wood storage effects (in the case of biogenic carbon accounting), and available cascading options. However, in the last years the **cascading use of wood has made little progress**. On the one hand, there is a lack of production capacity in Switzerland for the material use of the wood assortments currently used for energy, i.e. the pulp, paper and particle board industries, meaning that energy use remains the only alternative. On the other hand, wood fuel is increasingly being used to replace non-renewable energy sources, which also has advantages. Based on a life cycle assessment, Vadenbo *et al.* (2018) demonstrated that increased deployment of domestic wood fuel – excluding forest wood apt for material applications – would be environmentally beneficial.

Lower-quality wood is usually used for energy, but biorefineries can make material use of it as well (Celebi *et al.* 2017). In a case study conducted through EPFL (Studer and Poldervaart 2017), a biorefinery was analyzed that produces butanol, acetone and ethanol biochemically, while converting residues thermochemically into synthetic gas. The synthetic gas is used to produce heat and power for the biorefinery, with one unit of biogenic carbon replacing 0.85 units of fossil CO₂. With the combined heat and fuel production approach, the GWP emissions substitution per unit of biogenic carbon reaches 2.5–3 times the value achieved with wood in a boiler (Celebi *et al.* 2019). Biorefineries do not exist yet in Switzerland but their feasibility is being discussed, especially in terms of supply, products, plant size, economic efficiency and competitiveness (Poldervaart 2016; Riediker 2021).

The allocation of wood is decided by the market and politics. Until now, decisions in favor of material use have been made in practice, mainly for economic reasons and not based on

environmental arguments. For example, the structurally decreasing demand for industrial wood and hardwood logs (deindustrialization) and the increasing demand for energy wood have led to a situation where forests contribute a large share of wood fuel. This situation might change in the future. The political objective of decarbonizing the European economy may give a new impetus to the material use of wood, because many fossil raw materials will have to be replaced by 2050. For example, in the insulation sector low-quality wood assortments can be used on a large scale, thus achieving higher prices and competing with their energy use. At the same time, however, the use of higher-quality wood for energy purposes is also emerging. Specifically, due to the growing gap-filling function of wood (and other biomass) in the energy sector, higher prices can now also be achieved for wood fuel. In this context, wood is more likely to be profitable in the heat and mobility sector than in the electricity sector, where photovoltaics (PV) and wind are more competitive in energy generation. However, PV and wind are intermittent and stochastic, with seasonal variation, while wood is a stored fuel that can be used on demand. In particular, wood can be converted into storable and easy-to-distribute fuel that can then be converted into multiple end-use energy services. Therefore, **an increasing demand for wood, for both material and energy use, can be expected**, and it could be more than a short-term phenomenon given the political goal of climate neutrality. Thus, it should be kept in mind that the possibilities for energy use presented here and their diffusion will also depend strongly on choices made in the broader context of wood material use and the use of forests in general. However, the demanded quantities of low-grade quality wood assortments can be very different for material and for energy purposes; in the case of material use, high-grade products can be produced from these assortments but in a lower quantity than is possible when the wood is used for energy.

4.2 Possibilities for energy use

The overall final energy consumption in Switzerland amounted to 834 PJ in 2019 and 747 PJ in 2020 (SFOE 2021a, Table 14), the first pandemic year. Out of these total values, 201 PJ in 2019 (24%) and 203 PJ in 2020 (27%) were derived from renewable resources (SFOE 2021b). Wood accounted for 4.7% (2019) and 5.3% (2020) of the renewable energy consumption. The main energy-consuming sectors are heat, mobility and electricity (for applications other than heat and mobility). Final consumption shares of renewable energies in 2020 were 24% for heat generation and 60% for

electricity consumption, while the share for mobility remained very low. Wood currently plays a substantial role in heating (ca. 11%; Holzenergie Schweiz 2016) but a subordinate role in electricity and especially in mobility.

Heating is the sector that consumes the most energy annually (SFOE 2021c). The total amount of energy consumed for heating decreased by 5% from 2019 to 2020, but its share of the total energy consumption increased (from 43% to 48%). Heat is used to provide hot water and heat for buildings, but also as process energy for industrial applications. Hot water and room heat are low-temperature applications that could also be provided by using electric heat pumps, solar collectors and geothermal energy, all of which have substantial potential for expansion. However, these alternatives are hardly suitable to provide high-temperature process heat. Combustion of wood for these applications thus seems to be the more suitable solution. Further alternatives to provide high-temperature process heat are combined heat and fuel production, generating gaseous or liquid biofuel, together with the industrial heat supply (e.g. the burning of wood residues after certain fractions, such as carbohydrates, have been used to synthesize liquid fuels or chemicals). However, the economic viability of providing process heat in industry is – in contrast to wood energy plants with heating networks – still a major challenge (SFOE 2021d). In order to replace fossil fuel, plans exist to expand thermal networks supplied with waste heat and renewable energies, which distribute heat or cold at different temperature levels (EnergieSchweiz 2021). Thermal networks powered by wood or other renewable energy sources will play an important role in the future, especially in agglomerations, as indicated in the Energy Perspectives 2050+ (SFOE 2022).

The mobility sector has the second-largest annual energy consumption, accounting for 38% of the total energy consumption in 2019 and 32% in 2020 (SFOE 2021c). Individual and freight transport together have the highest dependence on fossil fuels, with a share of 95% (SFOE 2019a). Hence, there is a growing need for electrification of this sector, yet this requires different measures for the individual sub-sectors. Short- and medium-term electrification is possible for individual passenger traffic by powering motor vehicles with batteries. There have also been encouraging developments in the electrification of long-haul trucks (Transport and Environment 2021). However, aviation will probably continue to rely on liquid fuels with a high energy density for many years. Thus, synthesizing these fuels from renewable resources, such as wood or other lignocellulosic feedstock, is highly recommended even if the total demand cannot be covered by domestic biomass.

Electricity is already an important energy carrier for several applications and – mainly due to the large contribution of hydropower in Switzerland – only ca. 40% of the current electricity mix is non-renewable (mainly nuclear; SFOE 2021b). For example, around 80 PJ/a of electricity must be additionally produced from renewable resources to meet today's energy demands. However, with the forecasted increased electrification of e.g. mobility, the future demand will likely increase. To satisfy this demand, the expansion of hydropower, photovoltaics, wind power and biomass energy are possible. It is estimated that hydro and wind power in Switzerland can only be increased by around 12 PJ/a and 32 PJ/a, respectively (SFOE 2019b). In contrast, the total potential for photovoltaics in Switzerland is estimated at 240 PJ/a (SFOE 2019c). However, the fluctuating nature of electricity generation with wind and solar technologies represents a challenge for the future energy system. To stabilize the power grid, new control systems need to be developed, together with technologies for electricity storage. Also, biomass can be converted into electricity, e.g. in CHP plants or by converting it into methane, which can then be electrified in a CHP plant either directly or on demand after being fed into the natural gas grid. Thus, the storage of methane is a promising means to balance the fluctuations of solar power.

Taken together, reasonable contributions of wood to the future energy system include the conversion into biofuels, the generation of high-temperature heat, and the balancing of fluctuations in solar power.

4.3 Optimal energy use

When designing the future Swiss energy system, the twofold nature of wood, as energy but also as a carbon source, has to be taken into consideration. Specifically, the utilization of wood (i.e. renewable carbon) to satisfy the energy demand of the national system not only contributes to the necessary supply of energy, but also serves as a way to replace fossil carbon. **In order to minimize carbon emissions and achieve maximum carbon circulation within the energy system, cascading wood, suitable CO₂ capture technologies, and carbon reuse strategies should be pursued.** By capturing and reconvertng the emitted carbon from the primary conversion technologies into valuable fuels and products, net carbon emissions are reduced and the overall carbon conversion efficiency within the national energy system is improved.

4.3.1 Decision models for optimal energy use in terms of CO₂ and energy efficiency

A **mathematical optimization model** that considers the entire energy system of Switzerland has been developed using the Energyscope concept (www.energyscope.ch) **to define the role of wood in the future energy mix** (Gironès *et al.* 2017; Li *et al.* 2020). The current situation regarding wood fuel utilization has been simulated and validated, accounting for the full wood use potential in boilers for heat production. However, considerations for efficiency maximization, variable process costs and feedstock availability, as well as the need to minimize emissions, make the search for alternative solutions for the future strategy imperative. To this end, almost one thousand different scenarios, accounting for diverse biomass availabilities and variable capital costs for the conversion processes, have been used to emulate the inherent uncertainty of these crucial parameters (Li *et al.* 2020). All employed scenarios consider the complete decarbonization of the energy system by 2050, and the aim to achieve the most efficient satisfaction of the system's energy demand while also minimizing the overall system cost.

A thorough analysis of the optimization results reveals that, for a variable feedstock of 13–17 TWh/a (47–61 PJ/a) of wood in the energy system, the entire amount is always used to produce gaseous and liquid biofuels or, to a small extent, contribute to the heat needs of the system (Li *et al.* 2020). In the majority of the optimized scenarios, woody biomass is directly converted into synthetic natural gas (SNG) via gasification and subsequent reforming. Indeed, wood gasification can provide the system with up to 9.5 TWh/a of SNG and constitutes the largest SNG gas production resource. On the other hand, part of the wood is used to deliver up to 3.7 TWh/a of synthetic liquid fuels using the coupling of biomass gasification and Fischer-Tropsch synthesis. According to the analysis of the different scenarios, the direct transformation of woody biomass into **synthetic liquid fuels represents up to 40%** of their production within the energy system. The remaining part is derived from alternative synthesis processes that use the Power-to-Gas option, converting captured CO₂ (including biogenic CO₂) and renewable hydrogen (H₂). H₂-production is also present in a limited but not negligible number of solutions, amounting to a maximum of 5.5 TWh/a of produced H₂ via wood gasification.

Wood gasification is preferentially used to produce gaseous and liquid biofuels, due to the easier storage. By contrast **the use of wood for heat and electricity in cogeneration plants appears to be rather limited, with a maximum of 18% of the total energy** delivered by wood conversion.

Indeed, heat is mainly produced by waste combustion and natural gas cogeneration. In addition, **waste heat recovery from high-temperature gasifiers can contribute 10–13% of the total high-temperature heat** produced. This is an important aspect, as it means that additional heat is delivered into the system but also that the efficiency of the biomass conversion process can be maximized. An additional amount of high-temperature heat (7–10%) can also be produced indirectly from wood by valorizing the produced SNG.

According to the scenario analysis, **direct production of electricity from wood is not favored**, as the necessary power can be delivered by using other renewable energy sources, such as photovoltaics (PV) and hydropower. This is to be expected based on comparisons of the biomass potentials and the capacity of the other renewable energy sources. In addition to electricity savings and efficiency, a key factor for managing the power supply in the Swiss energy system is still the utilization of the existing hydro dams and PV systems (H₂-storage), which hold the largest share of seasonal storage technologies (70–85% of the stored power; Li *et al.* 2021).

The use of biogenic carbon to indirectly store power in a chemical form using the Power-to-Gas concept is another important opportunity. Up to 6 TWh/a of renewable H₂ can be produced by electrolysis, using electricity that cannot be used directly in the energy system and that needs to be stored. In most solutions, however, the share of

Power-to-Gas in the total SNG production is limited to 4–6% due to economic and efficiency constraints, with most of the captured carbon being used to synthesize liquid biofuels for aviation.

The above considerations in the strategy of woody biomass utilization, mainly for biofuel and secondarily for heat and power production, assume that **efficient CO₂ sequestration strategies** are available to remove carbon from the system, which is not yet the case. Figure 15 shows the simulated monthly distribution of the flows of elemental carbon in the energy system in 2050. These values are derived from the equivalent CO₂ emissions attributed to the various energy-producing and -consuming processes and sectors. Positive values represent the processes releasing carbon in the energy system (i.e. biomass and waste consumption, as well as cement production), while negative values represent the processes removing existing carbon by using it as a resource in Power-to-X technologies (fuels and products, heat and power), as well as sequestration. Figure 15 refers to an indicative optimized scenario for 2050 and represents the equivalent mass of carbon that circulates in the energy system on a monthly basis. Moreover, the categorization makes it possible to identify the major “players” in the form of carbon-emitting or -consuming technologies. Sequestration technologies clearly play a crucial part in maintaining the carbon balance in the system. Indeed, this is true for all the results, where CO₂ sequestration is always employed to further

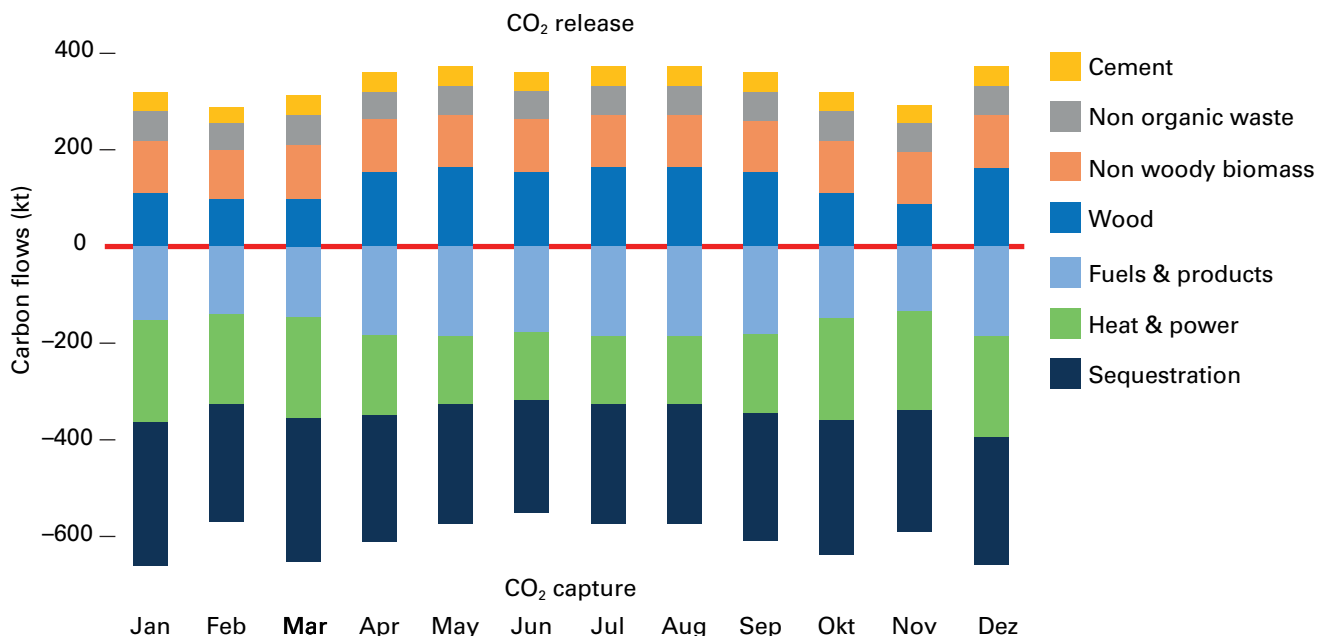

Figure 15: Monthly carbon flow distribution in one scenario of the Swiss energy system in 2050. Positive values correspond to CO₂ release (biomass and waste conversion, as well as cement production), while negative values correspond to captured CO₂ use, as in Power-to-X technologies (fuels and products, heat and power, sequestration). Even if a majority of the carbon flows can be closed in the Swiss energy system, a significant share of the CO₂ has to be sequestered to reach net-zero carbon emissions in 2050. Adapted from Li *et al.* (2020).

remove carbon from the system and assist in complete decarbonization. Overall, the scenario analysis demonstrates that, **in order to achieve a net zero energy system in 2050, 10.5–12.6 Mt/a CO₂ needs to be sequestered.** This value also includes an average contribution of 6 Mt/a CO₂ from agricultural activities.

Summarized: In the net zero energy system simulated for Switzerland in 2050, biomass and especially woody biomass is used for energy management, either through heat and power production in winter periods or through the production of stored fuel that can be easily converted into fuels for transportation applications. Wood conversion processes are also used to produce high-temperature heat in industry through combined heat and transportation fuel production. The choice between liquid and gaseous fuel is mainly associated with choices of fuel for the transportation system. When aviation is included in the energy system, biojet fuel production is prioritized in biomass use. In addition, the conversion of biomass is used to produce biogenic CO₂, which in turn can be sequestered to compensate for the unavoidable emissions from agriculture.

4.3.2 Further considerations

Land requirement, social acceptance, income or employment effects, and biodiversity impact, as well as particulate matter and wood ash disposal, are further important criteria that should be taken into consideration when finding optimal solutions for energy wood use.

With regard to **land requirement**, the use of forest wood for energy can be efficient. In Switzerland, little area (4.3 km²) is required for the entire supply chain for use of the full sustainable potential (Bowman *et al.* 2021). Indeed, the forest is grown for different purposes and the additional area needed to exploit wood fuel only consists of construction zones (e.g. to build conversion facilities) and not forest or agricultural land. For all the woody biomass in Switzerland, it is estimated that an area of 12.6 km² would be necessary.

While in general the **social acceptance** of renewable energies is high, low local acceptance can hinder the development of renewable energy projects (Segreto *et al.* 2020). In principle, this also applies to bioenergy, but to a much lesser extent in the specific case of wood energy utilization. Nevertheless, in the realization of larger wood energy plants, complaints from affected persons can represent a relevant obstacle (SFOE 2021d). They can delay and increase the cost of projects to a considerable extent and ultimately prevent their realization. However, Swiss practice shows that complaints can be avoided through good

planning (especially site selection), as well as early and continuous communication with those affected. Approval procedures should be sped up by optimizing processes at the cantonal and municipal level. Clear insight into the elements that influence public attitudes is important (Wüstenhagen *et al.* 2007; Stadelmann-Steffen 2017).

Material use generates more **employment** (and value added) than energy use, both in absolute terms and in relation to one cubic meter of wood, at all stages of the value chain (FOEN 2013). The material use of wood requires more processing steps overall and results in high-value products. However, in Switzerland, there is a lack of processing capacity for the material use of the corresponding rather low-value wood assortments. The advantages of cascading utilization thus are currently of a theoretical nature, although the positive employment effects of energy utilization are valid already today and are not negligible.

The effect of wood production and bioenergy generation on **biodiversity** is highly complex. It is highly site-specific and depends on the species, the resource and supply chain management, and the type of energy conversion and use, which includes the recycling and disposal technologies applied. In general, the production of wood in forests can be considered particularly risky in terms of biodiversity losses. In Switzerland, the Forest Law requires the sustainable production of all wood assortments. Within the framework of sustainable forest management, natural regeneration of the forest and heterogeneous stand structures are promoted, while clear cuts are prohibited. The regulated use of wood causes periodic changes in habitat conditions, which can even improve the biodiversity of commercial forests (Krumm *et al.* 2020).

Swiss energy wood is not produced in dedicated plantations; it is a by-product of stem wood from sustainable forestry with long rotation periods. Furthermore, deadwood is preserved in a targeted manner and not used for energy as well as the use of brushwood is largely avoided. Overall full tree utilization, which is economically essential for the management of protection forests in the Alpine regions, could have negative consequences for deadwood users (fauna, fungi and flora) in the medium to long term. These consequences can be minimized by appropriate process design, e.g. returning the branches to the stand. So far, no negative impacts of the use of wood fuel from forests and landscapes on biodiversity in general have been shown. In the future, the greatest conflict with forest biodiversity is to be expected where rotation times are reduced, as shorter rotation times are currently propagated for reasons of climate adaptation and energy wood production (Bollmann and Braunisch 2013, 2016).

Wood combustion causes **pollutants, especially particulate matter** (PM), with various effects on health and climate. These PM pollutants can be divided into two groups: (i) primary aerosols in the form of salts, soot and condensable organic compounds (COC); and (ii) secondary aerosols – in addition to nitrates and sulfates – in particular secondary organic aerosols (SOAs), which are formed by photochemical reactions from volatile organic compounds (VOCs) in the atmosphere. These are also produced by poorly operated wood-burning stoves. The share of PM from wood combustion increases sharply in the winter months. Wood furnaces are a major source of PM in Switzerland (Baltensberger *et al.* 2013). However, this can be remediated with filters and other technologies and – not to be forgotten – with improved behavior on the part of the users and

better education to prevent illegal waste incineration and thus the generation and release of heavy metals, hydrochloric acid and dioxin.

In Switzerland, **wood ashes** (grate, cyclone, and filter ashes) are considered waste. They are highly enriched in heavy metals, which are partly present in the form of easily water-soluble chemical compounds. Wood ashes are thus disposed of in landfills (Tobler and Jutz 2020), and their disposal is regulated in the Ordinance on the Prevention and Disposal of Waste VVEA (SR 814.600). The nutrients contained in the wood are not yet used, so they are lost. As long as ashes cannot be used for fertilization, a wood-based economy cannot be fully circular. Notably, wood ash is also produced in wood gasification processes and not exclusively in combustion applications.

5 Conclusions and recommendations

Woody biomass is a unique biogenic carbon source that can be used for materials and energy in the form of various products and services. Its potentials are limited, however, and for reasons of ecological efficiency, preference should be given to the material use of wood. Nonetheless, wood can also make an important contribution to the energy transition as a renewable energy source, thanks to its storability, its flexibility in use, and its role as a biogenic carbon source. The **advantages of its energy use** are:

- i. woody biomass can be used to provide heat and electricity, as well as gaseous or liquid fuels;
- ii. all utilization pathways are suitable from a climate change perspective:
 - to replace fossil fuels and thus the emission of fossil CO₂,
 - to enable the capture of biogenic CO₂, which can be used for sequestration and thus negative carbon emissions;
- iii. wood fuel can stabilize the energy supply and the power grid because its large storage capacity helps to balance the grid and plays a central role in coupling different renewable energies.

To conclude, from a functional point of view, wood fuel is of greater importance than its comparatively low potential would suggest. Even more than other biomass, wood fuel is a **“wild card” for managing the energy transition** because of its exceptionally high flexibility in use.

The energy use of wood is **technologically heterogeneous**: biochemical, thermochemical and physical-chemical processes are necessary for its conversion into solid, gaseous or liquid energy carriers and to provide heat, electricity or mobility. The multiple conversion technologies have seen major advances with the help of BIOSWEET; however, some innovative technologies are not yet ready for the market. Further research and policy measures are needed to make the best use of wood in the context of the energy transition and climate change and to exploit the existing potentials as specified by the Energy Perspectives 2050+ (SFOE 2020a).

Advanced combustion technology enables expansion of the feedstock base (use of ash-rich biomass fuels including non-woody biomass) and thus facilitates the exploitation of the full potentials. The environmental impact of combustion can be greatly reduced through primary measures, such as advanced combustion concepts, staged combustion, process monitoring and combustion control. In addition, secondary measures, such as particle separation, enable the reduction of pollutants in air emissions even in small-scale applications. Last but not least, campaigns addressing the responsible use of wood-burning appliances can help reduce emissions.

From a climate protection point of view, wood should be used as a material whenever possible. This is especially true for forest wood, but also for wood from landscape maintenance, industrial wood residues, and waste wood. If possible, wood should be used in a cascading way, i.e. several times in succession for material and only then for energy. In Switzerland, there are limits to the cas-

cading use of low-quality wood, mainly because the classical wood industries (pulp, paper and particle board) have largely disappeared, mainly due to economic reasons. However, in the future, biorefineries may offer new opportunities for the material utilization of low-quality wood because it has a high biogenic carbon content. Additionally, it is important to ensure that all utilized wood originates from sustainable production, which is required in Switzerland.

The **limited supply** of wood means that larger investment projects need to check and secure its availability over time. In this context, the competition between material and energy use, but also possible changes in the political environment, must be taken into account. Regarding wood production in the forest, stock reduction strategies offer the possibility to increase the supply of energy wood in a time window of several decades.

The limited potential of wood as a valuable biogenic energy source **requires efficient utilization**. With the current use of fuel wood (95% as heat), this is not the case. In winter, heat and electricity production from wood is advantageous. However, **in terms of energy efficiency and the substitution of fossil carbon with biogenic carbon, it is most advantageous to produce high-temperature process heat and gaseous and liquid fuels. This is followed by electricity generation in CHP plants. Whenever possible, waste heat should be used and the released biogenic CO₂ captured** to offset unavoidable emissions, e.g. from agriculture. For

reasons relating to energy, climate and air pollution control policy, heat from wood should be generated primarily in larger automatic furnaces with heat networks.

The choice between gaseous or liquid fuel production depends mainly on the efficiency of the storage system and the intended transportation system. Although less efficient than synthetic natural gas production, liquid fuel production is preferred for transportation solutions that require high energy density and conversion efficiency, such as jet fuel. Furthermore, Power-to-Gas systems enable seasonal storage of renewable energy in the existing gas distribution networks.

Ultimately, the **concrete situation** of energy demand and supply of all renewable energy sources is crucial for determining the optimal utilization path of fuel wood. The evaluation of its utilization must be extended in the direction of a holistic impact assessment of the entire supply and utilization chain and supported with practice-oriented fundamentals and a political framework that allows a suitable exploitation of the Swiss wood fuel potential (cf. SFOE 2021d). **Research** on the future role of wood as an energy source should support such holistic approaches, with a particular focus on climate and sustainability effects and on the integration of wood into the systems of energy and resource utilization. This requires system-oriented and transdisciplinary research involving all stakeholders.

6 References

- Abu-Omar, M.M.; Barta, K.; Beckham, G.T.; Luterbacher, J.S.; Ralph, J.; Rinaldi, R.; Roman-Leshkov, Y.; Samec, J.S.M.; Selsand, B.F.; Wang, F., 2021: Guidelines for performing lignin-first biorefining. *Energy & Environmental Science* 14: 262–292. <https://doi.org/10.1039/d0ee02870c>
- Amiri, M.T.; Dick, G.R.; Questell-Santiago, Y.M.; Luterbacher, J.S., 2019: Fractionation of lignocellulosic biomass to produce uncondensed aldehyde-stabilized lignin. *Nature Protocols* 14, 3: 921–954. <https://doi.org/10.1038/s41596-018-0121-7>
- Antonini, C.; Treyer, K.; Moiola, E.; Bauer, C.; Schildhauer, T.J.; Mazzotti, M., 2021: Hydrogen from wood gasification with CCS—a techno-environmental analysis of production and use as transport fuel. *Sustainable Energy and Fuels* 5, 10: 2602–2621. <https://doi.org/10.1039/d0se01637c>
- Bajohr, S.; Schollenberger, D.; Buchholz, D.; Weinfurter, T.; Götz, M., 2014: Kopplung der PtG-Technologie mit thermochemischer Biomassevergasung: Das KIC Projekt «DemoSNG». *gwf – Gas/Erdgas* 155: 470–475.
- Baltensperger, U.; Bruns, E.; Dommen, J.; El Haddad, I.; Heringa, M.F.; Prévôt, A.S.H.; Slowik, J.G.; Weingartner, E.; Hueglin C.; Herich, H.; Keller, A.; Burtscher, H.; Heck, T.; Meyer, N.K., 2013: Holzfeuerungen: eine bedeutende Quelle von Feinstaub in der Schweiz. *Schweizerische Zeitschrift für Forstwesen* 164, 12: 420–427. <https://doi.org/10.3188/szf.2013.0420>
- Barroso, G.; Roth, S.; Nussbaumer, T., 2019a: Investigation of biomass conversion on a moving grate by pyrolysis gas analysis and fuel bed modelling. *Energy* 174: 897–910. <https://doi.org/10.1016/j.energy.2019.03.002>
- Barroso, G.; Hediger, L.; Nussbaumer, T., 2019b: Modelling and validation of biomass combustion in a screw burner. *Fuel* 254: 115672. <https://doi.org/10.1016/j.fuel.2019.115672>
- Barroso, G.; Nussbaumer, T.; Ulrich, M.; Reiterer, T.; Feldmeier, S., 2019c: Scale-up methodology for automatic biomass furnaces. *Journal of the Energy Institute* 93, 2: 591–604. <https://doi.org/10.1016/j.joei.2019.06.006>
- Bauer, C.; Hirschberg, S.; Bäuerle, Y.; Biollaz, S.; Calbry-Muzyka, A.; Cox, B.; Heck, T.; Lehnert, M.; Meier, A.; Prasser, H.-M.; Schenler, W.; Treyer, K.; Vogel, F.; Wieckert, H.C.; Zhang, X.; Zimmermann, M.; Burg, V.; Bowman, G.; Erni, M.; Saar, M.; Tran, M.Q., 2017: Potentials, costs and environmental assessment of electricity generation technologies. Final report in English with summaries in German and French. Paul Scherrer Institute. <https://www.psi.ch/sites/default/files/import/lea/HomeEN/Final-Report-BFE-Project.pdf>
- Blair, M.J.; Gagnon, B.; Klain, A.; Kulišić B., 2021: Contribution of biomass supply chains for bioenergy to sustainable development goals. *Land* 10, 2: 181. <https://doi.org/10.3390/land10020181>
- Bollmann, K.; Braunisch, V., 2013: To integrate or to segregate: balancing commodity production and biodiversity conservation in European forests. In: Kraus D., Krumm F. (eds.), *Integrative approaches as an opportunity for the conservation of forest biodiversity*, pp. 18–31. European Forest Institute (EFI).
- Bollmann, K., Braunisch, V., 2016: Auswirkungen des Klimawandels auf Bergwaldvogelarten. In: Pluess A.R., Augustin S., Brang P. (eds.), *Wald im Klimawandel. Grundlagen für Adaptationsstrategien*, pp. 287–309. Haupt. <https://www.dora.lib4ri.ch/wsl/islandora/object/wsl:10622>
- Bowman, G.; Burg, V.; Erni, M.; Thees, O.; Björnsen, A., 2021: Energy and land requirements for bioenergy. *GCB Bioenergy*, 13, 9: 1466–1480. <https://doi.org/10.1111/gcbb.12869>
- Brethauer, S.; Riediker, M.; Thees, O.; Studer, M.H.P., 2021: Die Rolle von Biomasse im zukünftigen schweizerischen Energie- und Rohstoffsystem. *Schweizerische Zeitschrift für Forstwesen* 172, 1: 7–15. <https://doi.org/10.3188/szf.2021.0007>
- Burg, V.; Bowman, G.; Erni, M.; Lemm, R.; Thees, O., 2018: Analyzing the potential of domestic biomass resources for the energy transition in Switzerland. *Biomass Bioenergy* 111: 60–69. <https://doi.org/10.1016/j.biombioe.2018.02.007>
- Burg, V.; Bowman, G.; Hellweg, S.; Thees, O., 2019: Long-term wet bioenergy resources in Switzerland: drivers and projections until 2050. *Energies* 12, 18: 3585. <https://doi.org/10.3390/en12183585>
- Celebi, A.D.; Ensinas, A.; Sharma, S.; Maréchal, F., 2017: Early-stage decision making approach for the selection of optimally integrated biorefinery processes. *Energy* 137: 908–916. <https://doi.org/10.1016/j.energy.2017.03.080>
- Celebi, A.D.; Sharma, S.; Ensinas, A.V.; Maréchal, F., 2019: Next generation cogeneration system for industry – combined heat and fuel plant using biomass resources. *Chemical Engineering Science* 204: 59–75. <https://doi.org/10.1016/j.ces.2019.04.018>
- CTI, Commission for Technology and Innovation (as of 2018 Innosuisse), 2013: Energy Competence Centres (SCCER): two applications receive go-ahead. press release. <https://www.admin.ch/gov/en/start/documentation/media-releases.msg-id-50481.html>
- CTU AG, 2014: Lignogaz – Methan aus Holz, Projektierung einer 2.67 MW für den Standort Mont-la-Ville (VD). Bundesamt für Energie. <https://www.aramis.admin.ch/Default?DocumentID=61169&Load=true>
- Diestel, S.; Weimar, H., 2014: Der Kohlenstoffgehalt in Holz- und Papierprodukten – Herleitung und Umrechnungsfaktoren. *Thünen Working Paper* 38. urn:nbn:de:gbv:253-201412-dn054392-0
- Du, Y.P.; Héroguel, F.; Luterbacher, J.S., 2018: Slowing the kinetics of alumina sol-gel chemistry for controlled catalyst overcoating and improved catalyst stability and selectivity. *Small* 14, 34: 1801733. <https://doi.org/10.1002/smll.201801733>
- EEA, European Environment Agency, 2018: The circular economy and the bioeconomy, partners in sustainability. EEA Report, 8. https://www.eea.europa.eu/ds_resolveuid/b2e1e5d081ab4ecf9503320c2bf9c4d1
- EnergieSchweiz, 2021: Faktenblatt Thermische Netze. <http://www.verenum.ch/Dokumente/Faktenblatt.pdf>

- EPA, United States Environmental Protection Agency, 2021: Understanding Global Warming Potentials. <https://epa.gov/ghgemissions/understanding-global-warming-potentials>. (last updated on March 2022)
- Erni, M.; Thees, O.; Lemm, R., 2017: Altholzpotenziale der Schweiz für die energetische Nutzung. Ergebnisse einer Vollerhebung. WSL Berichte 52. WSL. <https://www.dora.lib4ri.ch/wsl/islandora/object/wsl:9107>
- Erni, M.; Burg, V.; Bont, L.; Thees, O.; Ferretti, M.; Stadelmann, G.; Schweier, J., 2020: Current (2020) and Long-Term (2035 and 2050) Sustainable potentials of wood fuel in Switzerland. *Sustainability* 12, 22: 9749. <https://doi.org/10.3390/su12229749>
- Erni, M.; Holm, S.; Thees, O.; Schweier, J., 2021: Verfügbarkeit von Waldenergieholz in der Schweiz. Neue interaktive Karte. *Wald und Holz* 102, 6: 6–7. <https://www.dora.lib4ri.ch/wsl/islandora/object/wsl:27094>
- European Commission, 2012: Directorate-General for Research and Innovation, Innovating for sustainable growth: a bioeconomy for Europe. Publications Office. <https://data.europa.eu/doi/10.2777/6462>
- Fehrenbach, H.; Bischoff, M.; Böttcher, H.; Reise, J.; Hennenberg, K.J., 2022: The Missing Limb: Including Impacts of Biomass Extraction on Forest Carbon Stocks in Greenhouse Gas Balances of Wood Use. *Forests* 13, 3: 365. <https://doi.org/10.3390/f13030365>
- FHNW, University of Applied Sciences Northwestern Switzerland, 2019: ERA-LEARN Project, Development of a new low-cost low-emission micro-scale pellet stove with advanced process control. <https://www.era-learn.eu/network-information/networks/bioenergy/12th-joint-call-of-era-net-bioenergy-and-2nd-additional-call-of-bestf3/development-of-a-new-low-cost-low-emission-micro-scale-pellet-stove-with-advanced-process-control>. (last updated March 2020)
- FOAG, Federal Office for Agriculture, 2020: Voraussetzungen und Vorschriften für die Bewilligung von Biokohle. https://www.a-p-d.ch/wp-content/uploads/2021/11/Voraussetzungen_und_Vorschriften_fuer_die_Bewilligung_von_Biokohle__15.06.2020-BLW.pdf
- FOEN, Federal Office for the Environment, 2013: Inländische Wertschöpfung bei der stofflichen und energetischen Verwendung von Holz. Schlussbericht. https://www.bafu.admin.ch/dam/bafu/de/dokumente/wald-holz/fachinfo-daten/inlaendische_wertschoepfungbeiderstofflichenundenergetischenverw.pdf.download.pdf/inlaendische_wertschoepfungbeiderstofflichenundenergetischenverw.pdf
- FOEN, Federal Office for the Environment; SFOE, Swiss Federal Office of Energy; SECO, Staatssekretariat für Wirtschaft, (Eds.) 2018: Ressourcenpolitik Holz. Strategie, Ziele und Aktionsplan Holz.; Bern, Switzerland
- FOEN, Federal Office for the Environment, 2020: Jahrbuch Wald und Holz 2019
- FOEN, Federal Office for the Environment, 2021: Jahrbuch Wald und Holz 2020
- FOEN, Federal Office for the Environment, 2022: Jahrbuch Wald und Holz 2021
- Gassner, M.; Maréchal, F., 2008: Thermo-economic optimisation of the integration of electrolysis in synthetic natural gas production from wood. *Energy* 33, 2: 189–198. <https://doi.org/10.1016/j.energy.2007.09.010>
- Gassner, M.; Maréchal, F., 2012: Thermo-economic optimisation of the polygeneration of synthetic natural gas (SNG), power and heat from lignocellulosic biomass by gasification and methanation. *Energy & Environmental Science* 5, 2: 5768–5789. <https://doi.org/10.1039/C1EE02867G>
- Gassner, M.; Baciocchi, R.; Maréchal, F.; Mazzotti, M., 2009: Integrated design of a gas separation system for the upgrade of crude SNG with membranes. *Chemical Engineering and Processing: Process Intensification* 48, 9: 1391–1404. <https://doi.org/10.1016/j.cep.2009.07.002>
- GAYA, 2021: Project GAYA. <http://www.projetgaya.com/en>. (last updated March 2022)
- Geleynse, S.; Brandt, K.; Garcia-Perez, M.; Wolcott, M.; Zhang, X., 2018: The alcohol-to-jet conversion pathway for drop-in biofuels: Techno-Economic Evaluation. *Chemistry-Sustainability-Energy-Materials* 11, 21: 3728–3741. <https://doi.org/10.1002/cssc.201801690>
- Gironès, V.C.; Moret, S.; Peduzzi, E.; Nasato, M.; Maréchal, F., 2017: Optimal use of biomass in large-scale energy systems: Insights for energy policy. *Energy* 137: 789–797. <https://doi.org/10.1016/j.energy.2017.05.027>
- Held, J., 2016: SNG from Wood – the biogas project. In: Schildhauer, T.J.; Biollaz, S.M. (eds.), *Synthetic natural gas from coal, dry biomass, and Power-to-Gas applications*, pp. 181–190. Wiley. <https://doi.org/10.1002/9781119191339.ch6>
- Heyne, S.; Seemann, M.; Schildhauer, T.J., 2016: Coal and biomass gasification for SNG production. In: Schildhauer, T.J.; Biollaz, S.M. (eds.), *Synthetic natural gas from coal, dry biomass, and Power-to-Gas applications*, pp. 5–40. Wiley. <https://doi.org/10.1002/9781119191339.ch2>
- Holzenergie Schweiz, 2016: Warum Holzenergie für das Klima. [https://www.holzenergie.ch/ueber-holzenergie/warum-holzenergie/fuer-das-klima.html#:~:text=Heizen%20mit%20Holz!&text=Holzenergie%20tr%C3%A4gt%20aktuell%20\(Stand%202016,Annteil%20am%20Schweizer%20Energienmix%20bei](https://www.holzenergie.ch/ueber-holzenergie/warum-holzenergie/fuer-das-klima.html#:~:text=Heizen%20mit%20Holz!&text=Holzenergie%20tr%C3%A4gt%20aktuell%20(Stand%202016,Annteil%20am%20Schweizer%20Energienmix%20bei)
- Husgafvel, R.; Linkosalmi, L.; Hughes, M.; Kanerva, J.; Dahl, O., 2018: Forest sector circular economy development in Finland: A regional study on sustainability driven competitive advantage and an assessment of the potential for cascading recovered solid wood. *Journal of Cleaner Production* 181: 483–497. <https://doi.org/10.1016/j.jclepro.2017.12.176>
- IEA Bioenergy, 2019: Task 39: ‘Drop-in’ Biofuels. <https://www.ieabioenergy.com/wp-content/uploads/2019/09/Task-39-Drop-in-Biofuels-Full-Report-January-2019.pdf>
- IEA Bioenergy, 2020: The use of forest biomass for climate change mitigation: dispelling some misconceptions. <https://www.ieabioenergy.com/blog/publications/the-use-of-forest-biomass-for-climate-change-mitigation-dispelling-some-misconceptions/>

- IEA Bioenergy, 2021: Campaigns questioning the use of woody biomass for energy are missing key facts. <https://www.ieabioenergy.com/blog/publications/campaigns-questioning-the-use-of-woody-biomass-for-energy-are-missing-key-facts/>. (last updated March 2022)
- IEA Bioenergy, 2022: Fossil vs biogenic CO₂ emissions. <https://www.ieabioenergy.com/iea-publications/faq/woodybiomass/biogenic-co2/>. (last updated March 2022)
- Krumm, F.; Rigling, A.; Bollmann, K.; Brang, P.; Dürr, C.; Gessler, A.; Schuck, A.; Schulz-Marty, T.; Winkel, G., 2020: Synthesis: improving biodiversity conservation in European managed forests needs pragmatic, courageous, and regionally-rooted management approaches. In: Krumm, F.; Schuck, A.; Rigling A. (eds.), *How to balance forestry and biodiversity conservation – A view across Europe*, pp. 609–633. European Forest Institute (EFI); Swiss Federal Institute for Forest, Snow and Landscape Research (WSL). <https://www.dora.lib4ri.ch/wsl/islandora/object/wsl:25784>
- Leimert, J.M.; Neubert, M.; Treiber, P.; Dillig, M.; Karl, J., 2018: Combining the Heatpipe Reformer technology with hydrogen-intensified methanation for production of synthetic natural gas. *Applied Energy* 217, 37–46. <https://doi.org/10.1016/j.apenergy.2018.02.127>
- Lemm, R.; Haymoz, R.; Björnson Gurung, A.; Burg, V.; Strebel, T.; Thees, O., 2020: Replacing fossil fuels and nuclear power with renewable energy: utopia or valid option? A Swiss case study of bioenergy. *Energies* 13, 8: 2051. <https://doi.org/10.3390/en13082051>
- Li, X.; Damartzis, T.; Stadler, Z.; Moret, S.; Meier, B.; Friedl, M.; Maréchal, F., 2020: Decarbonization in complex energy systems: a study on the feasibility of carbon neutrality for Switzerland in 2050. *Frontiers in Energy Research* 8: 549615. <https://doi.org/10.3389/fenrg.2020.549615>
- Li, X.; Damartzis, T.; Maréchal, F., 2021: Decarbonization of Swiss Energy Systems in 2050: Integrated Scenario Analysis with the SES-EPFL Model. SCCER JASM Report. EPFL. https://sccer-jasm.ch/JASMPapers/JASM_results_ses_epfl.pdf
- Losey, S.; Wehrli, A., 2013: Schutzwald in der Schweiz. Vom Projekt SilvaProtect-CH zum harmonisierten Schutzwald. Bundesamt für Umwelt (BAFU). <https://www.news.admin.ch/news/message/attachments/29559.pdf>
- Mehli, A.; Winkler, D.; Griffin, T.; Kaiser, S.; Garcia, A.; Gerner, G.; Kulli, B.; Baier, U.; Kühni, M.; Treichler, A., 2021: HTC Innovationscampus Rheinmühle -Pilotanlage zur Hydrothermalen Karbonisierung: Prozessoptimierung & Verfahrenserkenntnisse. Schlussbericht. Bundesamt für Energie(BFE). <https://www.aramis.admin.ch/Texte/?ProjectID=40894>
- Mehr, J.; Vadenbo, C.; Steubing, B.; Hellweg, S., 2018: Environmentally optimal wood use in Switzerland – Investigating the relevance of material cascades. *Resources, Conservation and Recycling* 131: 181–191. <https://doi.org/10.1016/j.resconrec.2017.12.026>
- Michel, J.B., 2017: TORPLANT – Pilote de polygénération de pellets Torpalnt de biomasse torréfiée, de chaleur et d'électricité. DGE-DIREN. Canton de Vaud.
- Mohr, L.; Burg, V.; Thees, O.; Trutnevyte, E., 2019: Spatial hot spots and clusters of bioenergy combined with socio-economic analysis in Switzerland. *Renewable Energy* 140: 840–851. <https://doi.org/10.1016/j.renene.2019.03.093>
- Moioli, E.; Schildhauer, T., 2021: Negative CO₂ emissions from flexible biofuel synthesis: concepts, potentials, technologies. *Renewable and Sustainable Energy Reviews* 158: 112120. <https://doi.org/10.1016/j.rser.2022.112120>
- Nussbaumer, T., 2017: The role of aerosols from biomass combustion. 25th European Biomass Conference and Exhibition, 12–15. Juni 2017, Stockholm. https://task32.ieabioenergy.com/wp-content/uploads/2017/07/Nussbaumer_IEA_T32_Aerosol-Report_2017_07_14.pdf
- Nussbaumer, T.; Lauber, A.; Hennemann, P.; Meierhans, T.; Guthoerl, D.; Jacquet, S., 2019: Staubförmiger Biomasse-Brennstoff für den Thermoölprozess. Schlussbericht. Bundesamt für Umwelt (BAFU). <https://www.aramis.admin.ch/Default?DocumentID=50894&Load=true>
- Nussbaumer, T., 2020: Introduction to biomass combustion and pollutant reduction in wood stoves and boilers. 6th Central European Biomass Conference, 22–24. Januar 2020, Graz. https://task32.ieabioenergy.com/wp-content/uploads/sites/2/2020/07/01_2020-01-23_CEBC-Graz_Nussbaumer-Homepage.pdf
- Norton, M.; Walloe, L.; Brack, D.; Booth, M.; Jones, M.B., 2021: Time is of the essence when it comes to forest bioenergy. *GCB Bioenergy* 14: 108–109. <https://doi.org/10.1111/gcbb.12905>
- Peduzzi, E.; Boissonnet, G.; Haarlemmer, G.; Maréchal, F., 2018: Thermo-economic analysis and multi-objective optimisation of lignocellulosic biomass conversion to Fischer-Tropsch fuels. *Sustainable Energy & Fuels* 2, 5: 1069–1084. <https://doi.org/10.1039/C7SE00468K>
- Peduzzi, E.; Tock, L.; Boissonnet, G.; Maréchal, F., 2013: Thermo-economic evaluation and optimization of the thermo-chemical conversion of biomass into methanol. *Energy* 58: 9–16. <https://doi.org/10.1016/j.energy.2013.05.029>
- Poldervaart, P., 2016: 2. Workshop zum Thema «Antriebskräfte und wichtige Voraussetzungen für die Entwicklung einer holzbasierten Bioaffinerie in der Schweiz». Kurzbericht. Ressource Holz (NFP 66), Hochschule für Agrar-, Forst- und Lebensmittelwissenschaften HAFL, Zollikofen. http://www.nfp66.ch/SiteCollectionDocuments/nfp66_kurzbericht_wsii_schlussversion.pdf
- Questell-Santiago, Y.M.; Galkin, M.V.; Barta, K.; Luterbacher, J.S., 2020: Stabilization strategies in biomass depolymerization using chemical functionalization. *Nature Reviews Chemistry* 4, 6: 311–330. <https://doi.org/10.1038/s41570-020-0187-y>
- Rabou, L.P.; Bos, L., 2012: High efficiency production of substitute natural gas from biomass. *Applied Catalysis B: Environmental* 111–112: 456–460. <https://doi.org/10.1016/j.apcatb.2011.10.034>
- Rabou, L.P.; Van der Drift, A.; Van Dijk, H.A.; Van der Meijden, C.M.; Vreugdenhil, B.J., 2016: MILENA indirect gasification, OLGA tar removal, and ECN process for methanation. In: Schildhauer, T.J.; Biollaz, S.M. (eds.), *Synthetic natural gas from coal, dry biomass,*

- and Power-to-Gas applications, pp. 231–248. Wiley. <https://doi.org/10.1002/9781119191339.ch9>
- Raven, P. et al., 2021: Letter regarding the use of forest bioenergy. Hundreds of scientists affirm that trees are more valuable alive than dead — both for climate and for biodiversity. Woodwell Climate Research Center. <https://www.woodwellclimate.org/letter-regarding-use-of-forests-for-bioenergy/>
- Riediker, M., 2021: Holz in einer zukünftigen Schweizer Bioökonomie. Holz – zentrale Ressource in einer zukünftigen Bioökonomie. Montagskolloquium, 1. Februar 2021, ETH Zürich. https://ethz.ch/content/dam/ethz/special-interest/usys/ites/ites-dam/MoKo/2021/01FEB_01_Riediker_Holz.pdf
- Rigling, A.; Schaffer, H.P. (Eds.), 2015: Forest Report 2015. Condition and Use of Swiss Forests. Federal Office for the Environment (FOEN). https://www.bafu.admin.ch/dam/bafu/en/dokumente/wald-holz/uz-umwelt-zustand/waldbericht_2015.pdf.download.pdf/forest_report_2015.pdf
- Ropp, J.; Stäger, T.; Röthlisberger, R.; Roth, S.; Bourgeois J.-P., 2019: XyloClean (Post-traitement de fumées de générateurs de chaleur domestiques à bois). Rapport final. Federal Office for the Environment (FOEN). https://heig-vd.ch/docs/default-source/doc-institut-igt/ofev-ref-1011-07300_rapportfinal_xyloclean_ii_v2.pdf?sfvrsn=b6be48e5_0
- Rozmysłowicz, B.; Yeap, J.H.; Elkhaiary, A.M.I.; Talebi A.M.; Shahab, R.L.; Questell-Santiago, Y.M.; Xiros, C.; Le Monnier, B.P.; Studer, M.H.; Luterbach, J.S., 2019: Catalytic valorization of the acetate fraction of biomass to aromatics and its integration into the carboxylate platform. *Green Chemistry* 21, 10: 2801–2809. <https://pubs.rsc.org/en/content/article-landing/2019/GC/C9GC00513G>
- Schildhauer, T.J.; Biollaz, S.M.A., 2015: Reactors for catalytic methanation in the conversion of biomass to Synthetic Natural Gas (SNG). *Chimia* 69, 10: 603–607. <https://doi.org/10.2533/chimia.2015.603>
- Schildhauer, T.J., 2018: Biosynthetic natural gas (Bio-SNG), In: Meyers, R.A. (Eds), *Encyclopedia of Sustainability Science and Technology*, pp. 1065–1080. Springer. https://doi.org/10.1007/978-1-4419-0851-3_256
- Schildhauer, T.J., 2016: Methanation for SNG production – Chemical reaction engineering aspects, In: Schildhauer, T.J.; Biollaz, S.M.A. (Eds.), *Synthetic natural gas from coal, dry biomass, and Power-to-Gas applications*, pp. 77–159. Wiley & Sons. <https://doi.org/10.1002/9781119191339.ch4>
- Schildhauer, T.; Kroon, P.; Höftberger, E.; Molioli, E.; Reichert, G.; Kupelwieser, F., 2021: Technologies for Flexible Bioenergy, IEA Bioenergy: Task 44. <https://task44.ieabioenergy.com/publications/technologies-for-flexible-bioenergy-2021>
- Schmid, M.; Stucki, R.; Griffin, T., 2014: Biomasse-WKK mit 60 kW Heisslufturbine. In: Tagungsband 18. Status-Seminar, Forschen für den Bau im Kontext von Energie und Umwelt, ETH Zürich. https://dd7557c7-8e89-4a2f-99df-c2aae0023398.filesusr.com/ugd/4e60ac_8ca0b-9896f8a4551a97b449a728451f4.pdf
- Schnorf, V.; Trutnevyte, E.; Bowman, G.; Burg, V., 2021: Analysing costs, energy and CO₂ emissions of the main forest wood and manure transport chains in Switzerland. *Journal of Cleaner Production* 293: 125971. <https://doi.org/10.1016/j.jclepro.2021.125971>
- Scholz, D.; Xie, J.; Kröcher, O.; Vogel, F., 2019: Mechanochemistry-assisted hydrolysis of softwood over stable sulfonated carbon catalysts in a semi-batch process. *RSC Advances* 9, 57: 33525–33538.
- Scholz, D.; Kröcher, O.; Vogel, F., 2018: Deactivation and regeneration of sulfonated carbon catalysts in hydrothermal reaction environments, *ChemSusChem* 11, 2189–2201.
- Schulze, E.D.; Rock, J.; Kroihner, F.; Egenolf, V.; Wellbrock, N.; Irslinger, R.; Bolte, A.; Spellmann, H., 2021: Speicherung von Kohlenstoff im Ökosystem und Substitution fossiler Brennstoffe Klimaschutz mit Wald. *Biologie in unserer Zeit* 51, 1: 46–54. <https://www.biuz.de/index.php/biuz/article/view/4103>
- Schumacher, F.; Nussbaumer, T.; Good, J., 2020: System integration and dimensioning of heat storage tanks in heating plants with automated wood furnaces. 6th Central European Biomass Conference, 22–24. Januar 2020, Graz.
- Segreto, M.; Principe, L.; Desormeaux, A.; Torre, M.; Tomassetti, L.; Tratzi, P.; Paolini, V.; Petracchini, F., 2020: Trends in social acceptance of renewable energy across Europe—A literature review. *International Journal of Environmental Research and Public Health* 17: 9161. <https://doi.org/10.3390/ijerph17249161>
- SFOE, Swiss Federal Office of Energy, 2019a: Schweizerische Gesamtenergiestatistik 2018. Swiss Federal Office of Energy (SFOE). <https://pubdb.bfe.admin.ch/de/publication/download/9774>
- SFOE, Swiss Federal Office of Energy, 2019b: Wasserkraftpotenzial der Schweiz. Abschätzung des Ausbaupotenzials der Wasserkraftnutzung im Rahmen der Energiestrategie 2050. Bundesamt Energie.
- SFOE, Swiss Federal Office of Energy, 2019c: Schweizer Hausdächer und -fassaden könnten jährlich 67 TWh Solarstrom produzieren. Medienmitteilung des Bundesamts für Energie vom 15.4.2019.
- SFOE, Swiss Federal Office of Energy, 2020: Energieperspektiven 2050+. Zusammenfassung der wichtigsten Ergebnisse. Swiss Federal Office of Energy (SFOE). <https://www.bfe.admin.ch/bfe/de/home/politik/energieperspektiven-2050-plus.exturl.html/aHR0cHM-6Ly9wdWJkYi5iZmUuYWwRtaW4uY2gvZGUvcHVib-GljYX/Rpb24vZG93bmxvYWQvMTAzMjA=.html>
- SFOE, Swiss Federal Office of Energy, 2021a: Schweizerische Gesamtenergiestatistik 2020.
- SFOE, Swiss Federal Office of Energy, 2021b: Schweizerische Statistik der erneuerbaren Energien. Ausgabe 2020.
- SFOE, Swiss Federal Office of Energy, 2021c: Analyse des schweizerischen Energieverbrauchs 2000–2020 nach Verwendungszwecken.
- SFOE, Swiss Federal Office of Energy, 2021d: Analyse von Hemmnissen und Massnahmen zur Ausschöpfung des Holzenergiepotenzials. Schlussbericht. Bundesamt für Energie BFE <https://pubdb.bfe.admin.ch/de/publication/download/10487>

- SFOE, Swiss Federal Office of Energy, 2022: Energieperspektiven 2050+, Kurzbericht. <https://www.news.admin.ch/news/message/attachments/64121.pdf>
- Shahab, R.L.; Brethauer, S.; Davey, M.P.; Smith, A.G.; Vignolini, S.; Luterbacher, J.S.; Studer, M.H., 2020: A heterogeneous microbial consortium producing short-chain fatty acids from lignocellulose. *Science* 369, 6507: eabb1214. <https://doi.org/10.1126/science.abb1214>
- Shuai, L.; Amiri, M.T.; Questell-Santiago, Y.M.; Héroguel, F.; Li, Y.; Kim, H.; Meilan, R.; Chapple, C.; Ralph, J.; Luterbacher, J.S., 2016: Formaldehyde stabilization facilitates lignin monomer production during biomass depolymerization. *Science* 354, 6310: 329–333. <https://doi.org/10.1126/science.aaf7810>
- Stadelmann-Steffen, I., 2017: Social acceptance of energy investments. SCCER School 17–20. Oktober 2017, Engelberg. http://www.sccer-soe.ethz.ch/export/sites/sccersoe/news/galleries/dwn_sccerschool2017/T-13_SC-CER-School_Stadelmann.pdf_2063069299.pdf
- Sterman, J.; Moomaw, W.; Rooney-Varga, J.-N.; Siegel, L., 2022: Does wood bioenergy help or harm the climate? *Bulletin of the Atomic Scientists* 78, 3: 128–138. <https://doi.org/10.1080/00963402.2022.2062933>
- Steubing, B., 2013: Die Ökobilanz der energetischen Holzverwertung: Faktoren für einen hohen ökologischen Nutzen. *Schweizerische Zeitschrift für Forstwesen* 164, 12: 408–419. <https://doi.org/10.3188/szf.2013.0408>
- Studer, M.; Poldervaart, P., 2017: Neue Wege zur holzbasierten Bioraffinerie, Thematische Synthese im Rahmen des Nationalen Forschungsprogramms NFP66 «Ressource Holz», Schweizerischer Nationalfonds. http://www.nfp66.ch/SiteCollectionDocuments/NFP66_Teilsynthese_2_Bioraffinerie_DE.pdf
- Suter, F.; Steubing, B.; Hellweg, S., 2017: Life cycle impacts and benefits of wood along the value chain: The Case of Switzerland. *Journal of Industrial Ecology* 21: 874–886. <https://doi.org/10.1111/jiec.12486>
- Teske, S.L., 2014: Integrating rate-based models into a multi-objective process design & optimisation framework using surrogate models. Dissertation EPF Lausanne, Thesis 6302. <https://infoscience.epfl.ch/record/201637>
- Thees, O.; Burg, V.; Erni, M.; Bowman, G.; Lemm, R., 2017: Biomassepotenziale der Schweiz für die energetische Nutzung. Ergebnisse des Schweizerischen Energiekompetenzzentrums SCCER BIOSWEET. *WSL Berichte* 57. WSL. <https://www.dora.lib4ri.ch/wsl/islandora/object/wsl:13277>
- Thees, O.; Erni, M.; Lemm, R.; Stadelmann, G.; Zenner, E.K., 2020: Future potentials of sustainable wood fuel from forests in Switzerland. *Biomass and Bioenergy* 141: 105647. <https://doi.org/10.1016/j.biombioe.2020.105647>
- Thürig, E.; Kaufmann, E., 2008: Waldbewirtschaftung zur Senkenerhöhung? Mögliche Konfliktfelder und Synergien. *Schweizerische Zeitschrift für Forstwesen* 159, 9: 281–287. <https://doi.org/10.3188/szf.2008.0281>
- Thürig, E.; Kaufmann, E., 2010: Increasing carbon sinks through forest management: a model-based comparison for Switzerland with its Eastern Plateau and Eastern Alps. *European Journal of Forest Research* 129, 4: 563–572. <https://doi.org/10.1007/s10342-010-0354-7>
- Tobler, M.; Jutz, M., 2020: Projekt HARVE, Holzaschen in der Schweiz, Aufkommen, Verwertung und Entsorgung von Holzaschen aus Anlagen grösser als 50 kW. Schlussbericht. https://www.bafu.admin.ch/dam/bafu/de/dokumente/wald-holz/fachinfo-daten/201210_HARVE_Schlussbericht_fachlich_def.pdf.download.pdf/201210_HARVE_Schlussbericht_fachlich_def.pdf
- Tock, L.; Maréchal, F., 2012: H₂ processes with CO₂ mitigation: Thermo-economic modeling and process integration. *International Journal of Hydrogen Energy* 37, 16: 11785–11795. <https://doi.org/10.1016/j.ijhydene.2012.05.046>
- Transport & Environment, 2021: Unlocking electric trucking in the EU: recharging along highways – campaigning for cleaner transport in Europe. Transport & Environment (transportenvironment.org). https://www.transportenvironment.org/wp-content/uploads/2021/07/202102_pathways_report_final.pdf
- Vadenbo, C.; Tonini, D.; Burg, V.; Fruergaard Astrup, T.; Thees, O.; Hellweg, S., 2018: Environmental optimization of biomass use for energy under alternative future energy scenarios for Switzerland. *Biomass and Bioenergy* 119: 462–472. <https://doi.org/10.1016/j.biombioe.2018.10.001>
- van Dyk, S.; Su, J.; Mcmillan, J.D.; Saddler, J., 2019: Potential synergies of drop-in biofuel production with further co-processing at oil refineries. *Biofuels, Bioproducts and Biorefining* 13, 3: 760–775. <https://doi.org/10.1002/bbb.1974>
- Werner, F.; Taverna, R.; Hofer, P.; Thürig, E.; Kaufmann, E., 2010: National and global greenhouse gas dynamics of different forest management and wood use scenarios: a model-based assessment. *Environmental Science and Policy* 13, 1: 72–85. <https://doi.org/10.1016/j.envsci.2009.10.004>
- Winkler, D.; Engelbrecht, G.; Griffin, T.; Haymoz, R.; Marella, A.; Weiss, D.A., 2018: Characterization, testing and modelling of a variety of pulverized biomass fuels burnt in an air staged, swirl stabilized burner, European Biomass Conference and Expo, Paper 2AO.2.3, Copenhagen. <https://doi.org/10.5071/26thEUBCE2018-2AO.2.3>
- Wüest, J.; Lohberger, N.; Griffin, T.; Wildhaber, E., 2019: Field particle emission measurement on domestic wood firing systems retrofitted with electrostatic particle precipitators. 27th European Biomass Conference and Exhibition, 27–30 Mai 2019, Lissabon. <https://doi.org/10.5071/27THEUBCE2019-2AO.2.4>
- Wüstenhagen, R.; Wolsink, M.; Bürer, M.J., 2007: Social acceptance of renewable energy innovation. An introduction to the concept. *Energy Policy* 35, 5: 2683–2691. <https://doi.org/10.1016/j.enpol.2006.12.001>
- Zotter, P.; Richard, S.; Egli, M.; Rothen, B.; Nussbaumer, T., 2019: A simple method to determine cytotoxicity of water-soluble organic compounds and solid particles from biomass combustion in lung cells in vitro. *Environmental Science & Technology* 53, 7: 3959–3968. <https://doi.org/10.1021/acs.est.8b03101>

